

STERA 3D

Structural Earthquake Response Analysis 3D

Technical Manual

Version 3.2

Dr. Taiki SAITO

BUILDING RESEARCH INSTITUTE, JAPAN

UPDATE HISTORY

2007/07/17	STERA_3D Technical Manual Ver.1.0 is uploaded.
2007/10/18	STERA_3D Technical Manual Ver.1.1 is uploaded. Explanation of passive damper element is added. Explanation of freedom vector is added.
2007/10/31	STERA_3D Technical Manual Ver.1.2 is uploaded. Mistakes in transformation matrix are modified.
2008/02/01	STERA_3D Technical Manual Ver.1.3 is uploaded. Base isolation element is modified. Multi-spring model for Column is modified.
2008/07/08	STERA_3D Technical Manual Ver.2.0 is uploaded. Masonry element is installed.
2009/01/12	STERA_3D Technical Manual Ver.2.1 is uploaded. Viscous damper element is installed.
2009/10/06	STERA_3D Technical Manual Ver.2.2 is uploaded. Chapter 7 and Chapter 8 are added.
2010/03/30	STERA_3D Technical Manual Ver.2.3 is uploaded. Chapter 9 and Chapter 10 are added.
2010/08/16	STERA_3D Technical Manual Ver.2.4 is uploaded. The definition of shear deformation for passive damper is added.
2010/08/31	STERA_3D Technical Manual Ver.2.5 is uploaded. Explanation of floor element is added.
2010/10/20	STERA_3D Technical Manual Ver.2.6 is uploaded. Connection panel is installed.
2010/11/08	STERA_3D Technical Manual Ver.2.7 is uploaded. The freedom of walls in case they are connected in series is explained in Chapter 4.
2010/12/01	STERA_3D Technical Manual Ver.2.8 is uploaded. The error for calculating yield rotation of nonlinear spring is fixed..
2011/02/02	STERA_3D Technical Manual Ver.2.9 is uploaded. New definition of mass distribution is added in Chapter 5.
2011/02/14	STERA_3D Technical Manual Ver.3.0 is uploaded. Element model for wall panel is added.
2011/09/26	STERA_3D Technical Manual Ver.3.1 is uploaded. The equation of shear strength of wall element is modified.
2011/11/14	STERA_3D Technical Manual Ver.3.2 is uploaded. Chapter for the release of unbalance force is added.

INDEX

- 1. Basic Condition**
 - 1.1 Coordinate**
- 2. Constitutive Equation of Elements**
 - 2.1 Beam**
 - 2.2 Column**
 - 2.3 Wall**
 - 2.4 Wall Panel**
 - 2.5 External Spring**
 - 2.6 Base Isolation**
 - 2.7 Masonry Wall**
 - 2.8 Passive Damper**
 - 2.9 Floor Element**
 - 2.10 Connection Panel**
- 3. Hysteresis Models of Nonlinear Springs**
 - 3.1 Beam**
 - 3.2 Column**
 - 3.3 Wall**
 - 3.4 Wall Panel**
 - 3.5 External Spring**
 - 3.6 Base Isolation**
 - 3.7 Masonry Wall**
 - 3.8 Passive Damper**
- 4. Freedom Vector**
 - 4.1 Node freedom**
 - 4.2 Freedom vector**
 - 4.3 Dependent freedom**
 - 4.4 Formulation of independent displacement of the element**
- 5. Equation of Motion**
 - 5.1 Mass matrix**
 - 5.2 Stiffness matrix**
 - 5.3 Damping matrix**
 - 5.4 Input ground acceleration**
 - 5.5 Equation of motion**
 - 5.6 Numerical integration method**
 - 5.7 Energy**
- 6. Nonlinear Static Push-Over Analysis**
 - 6. 1 Lateral distribution of earthquake force**

6.2 Capacity Curve

7. Others

7.1 Decomposition of shear and flexural deformation

7.2 P-D effect

7.3 Unbalance force correction

1. Basic Condition

1.1 Coordinate

(1) Global Coordinate

The global coordinate is defined as the right-hand coordinate as shown in Figure 1-1-1.

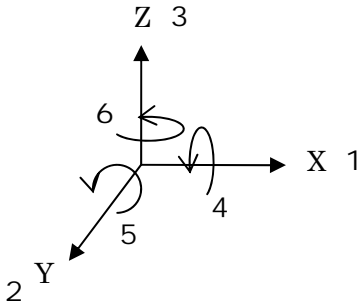

Figure 1-1-1 Global coordinate

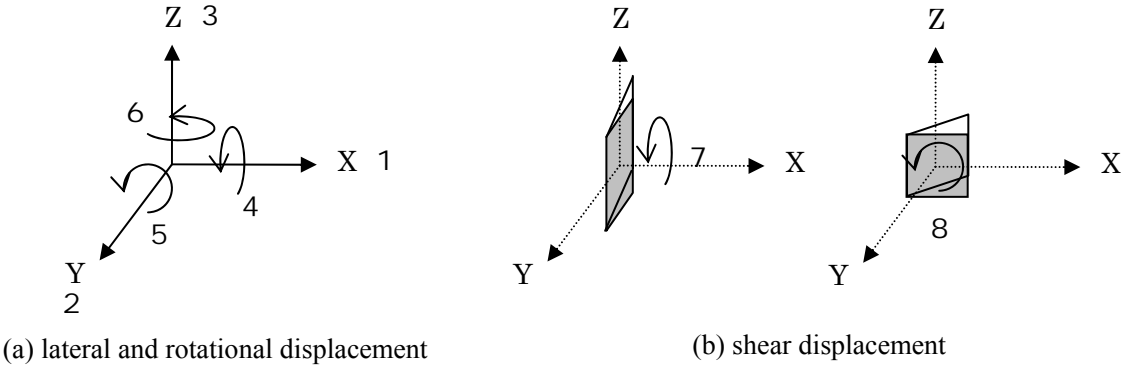

Figure 1-1-1 Global coordinate

(2) Local Coordinate

The local coordinate is defined for each element. The displacement freedoms and force freedoms are named with subscripts indicating the coordinate direction and node name. For example, the local coordinate of a beam element in Figure 1-2 is defined to have its x-axis in the same direction of the element axis. Also the displacement and force freedoms of a beam element are expressed as shown in Figure 1-1-2.

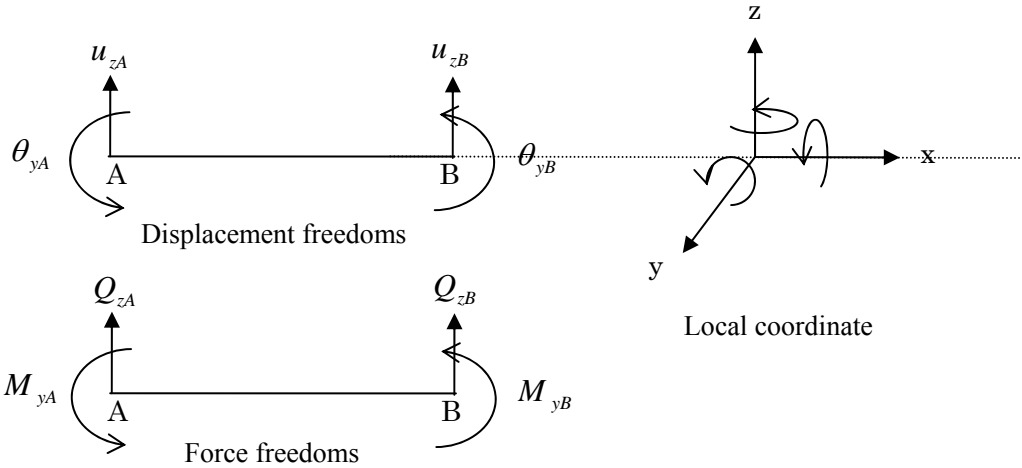

Figure 1-1-2 Local coordinate of a beam element

2. Constitutive Equation of Elements

3.1 Beam

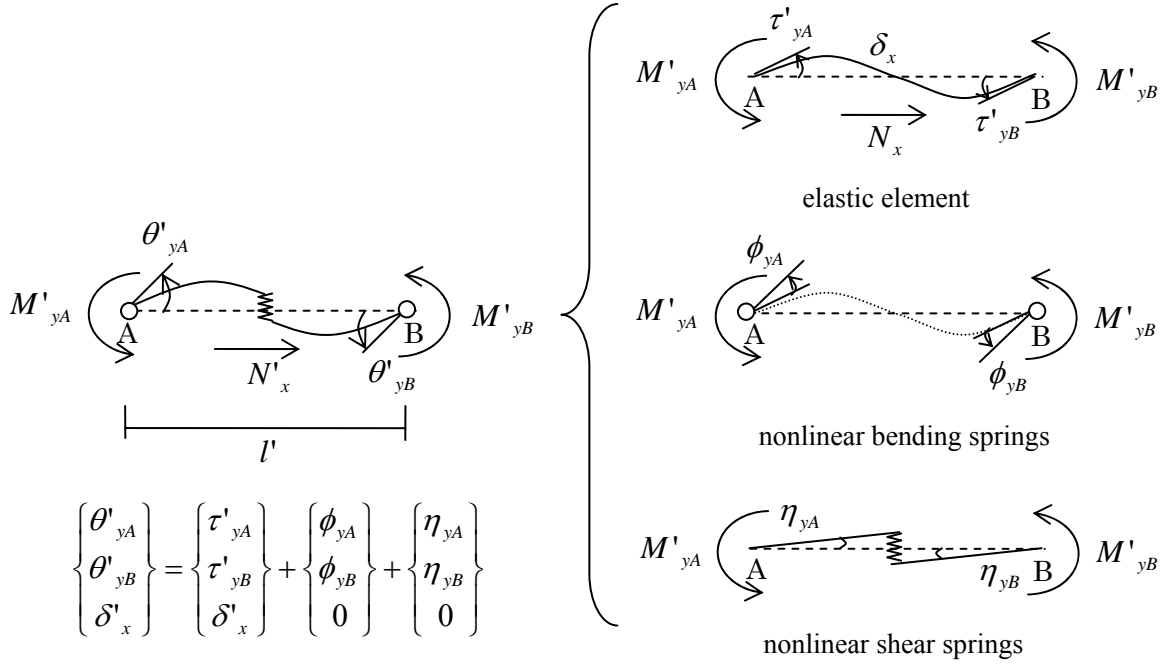

Figure 2-1-1 Element model for beam

Force-displacement relationship for elastic element

The relationship between the displacement vector and force vector of the elastic element in Figure 2-1-1 is expressed as follows:

$$\begin{Bmatrix} \tau'_{yA} \\ \tau'_{yB} \\ \delta'_x \end{Bmatrix} = \begin{bmatrix} \frac{l'}{3EI_y} & -\frac{l'}{6EI_y} & 0 \\ -\frac{l'}{6EI_y} & \frac{l'}{3EI_y} & 0 \\ 0 & 0 & \frac{l'}{EA} \end{bmatrix} \begin{Bmatrix} M'_{yA} \\ M'_{yB} \\ N'_x \end{Bmatrix} \quad (2-1-1)$$

where, E , I_y , A and l' are the modulus of elasticity, the moment of inertia of the cross-sectional area along y-axis, the cross-sectional area and the length of the element. The rotational displacement vector of the nonlinear bending springs is,

$$\begin{Bmatrix} \phi_{yA} \\ \phi_{yB} \end{Bmatrix} = \begin{bmatrix} f_{yA} & 0 \\ 0 & f_{yB} \end{bmatrix} \begin{Bmatrix} M'_{yA} \\ M'_{yB} \end{Bmatrix} \quad (2-1-3)$$

where, f_{yA} and f_{yB} are the flexural stiffness of nonlinear bending springs at both ends of the element. The rotational displacement vector from the shear deformation of the nonlinear shear spring is,

$$\begin{Bmatrix} \eta_{yA} \\ \eta_{yB} \end{Bmatrix} = \begin{bmatrix} \frac{1}{k_{sz}l'} & \frac{1}{k_{sz}l'} \\ \frac{1}{k_{sz}l'} & \frac{1}{k_{sz}l'} \end{bmatrix} \begin{Bmatrix} M'_{yA} \\ M'_{yB} \end{Bmatrix} \quad (2-1-2)$$

where, k_{sz} is the shear stiffness of the nonlinear shear spring. Then, the displacement vector of the beam element is obtained as the sum of the above three displacement vectors.

$$\begin{Bmatrix} \theta'_{yA} \\ \theta'_{yB} \\ \delta'_x \end{Bmatrix} = \begin{Bmatrix} \tau'_{yA} \\ \tau'_{yB} \\ \delta'_x \end{Bmatrix} + \begin{Bmatrix} \phi_{yA} \\ \phi_{yB} \\ 0 \end{Bmatrix} + \begin{Bmatrix} \eta_{yA} \\ \eta_{yB} \\ 0 \end{Bmatrix} = [f_B] \begin{Bmatrix} M'_{yA} \\ M'_{yB} \\ N'_x \end{Bmatrix} \quad (2-1-4)$$

where,

$$[f_B] = \begin{bmatrix} f_{yA} + \frac{l'}{3EI_y} + \frac{1}{k_{sz}l'} & -\frac{l'}{6EI_y} + \frac{1}{k_{sz}l'} & 0 \\ & f_{yB} + \frac{l'}{3EI_y} + \frac{1}{k_{sz}l'} & 0 \\ \text{sym.} & & \frac{l'}{EA} \end{bmatrix} \quad (2-1-5)$$

$[f_B]$ is the flexural stiffness matrix of the beam element. By taking the inverse matrix of $[f_B]$, the constitutive equation of the beam element is obtained as,

$$\begin{Bmatrix} M'_{yA} \\ M'_{yB} \\ N'_x \end{Bmatrix} = [f_B]^{-1} \begin{Bmatrix} \theta'_{yA} \\ \theta'_{yB} \\ \delta'_x \end{Bmatrix} = [k_B] \begin{Bmatrix} \theta'_{yA} \\ \theta'_{yB} \\ \delta'_x \end{Bmatrix} \quad (2-1-6)$$

where, $[k_B]$ is the stiffness matrix of the beam element.

Including rigid parts and node movement

Including rigid parts and node movement as shown in Figure 2-1-2, the rotational displacement vector is,

$$\begin{Bmatrix} \theta'_{yA} \\ \theta'_{yB} \end{Bmatrix} = \begin{Bmatrix} \theta_{yA} - \tau \\ \theta_{yB} - \tau \end{Bmatrix}, \quad \tau = \frac{(u_{zB} - \lambda_B l' \theta_{yB}) - (u_{zA} + \lambda_A l' \theta_{yA})}{l'}$$

$$= \begin{Bmatrix} \theta_{yA} + \frac{1}{l'} u_{zA} + \lambda_A \theta_{yA} - \frac{1}{l'} u_{zB} + \lambda_B \theta_{yB} \\ \theta_{yB} + \frac{1}{l'} u_{zA} + \lambda_A \theta_{yA} - \frac{1}{l'} u_{zB} + \lambda_B \theta_{yB} \end{Bmatrix} = \begin{bmatrix} \frac{1}{l'} & -\frac{1}{l'} & 1 + \lambda_A & \lambda_B \\ \frac{1}{l'} & -\frac{1}{l'} & \lambda_A & 1 + \lambda_B \end{bmatrix} \begin{Bmatrix} u_{zA} \\ u_{zB} \\ \theta_{yA} \\ \theta_{yB} \end{Bmatrix} \quad (2-1-7)$$

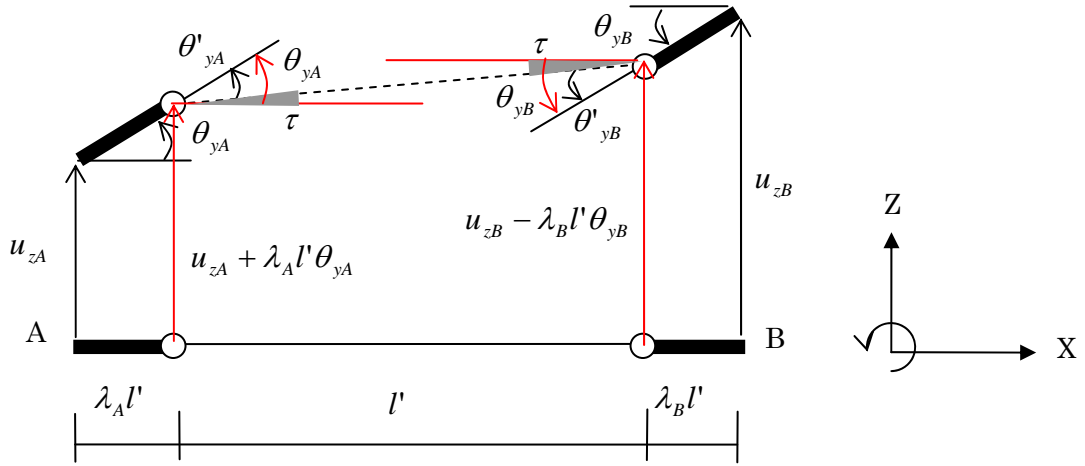

Figure 2-1-2 Including rigid parts and node movement

From node axial displacements, relative axial displacement is,

$$\delta'_x = \delta_{xB} - \delta_{xA} \quad (2-1-8)$$

Therefore

$$\begin{Bmatrix} \theta'_{yA} \\ \theta'_{yB} \\ \delta'_{xA} \\ \delta'_{xB} \end{Bmatrix} = \begin{bmatrix} 1 & 0 & 0 & 0 \\ 0 & 1 & 0 & 0 \\ 0 & 0 & -1 & 1 \end{bmatrix} \begin{Bmatrix} \theta'_{yA} \\ \theta'_{yB} \\ \delta_{xA} \\ \delta_{xB} \end{Bmatrix} = [n_B] \begin{Bmatrix} \theta'_{yA} \\ \theta'_{yB} \\ \delta_{xA} \\ \delta_{xB} \end{Bmatrix} \quad (2-1-9)$$

Combining Equations (2-1-7) and (2-1-9),

$$\begin{Bmatrix} \theta'_{yA} \\ \theta'_{yB} \\ \delta'_{xA} \\ \delta'_{xB} \end{Bmatrix} = \begin{bmatrix} \frac{1}{l'} & -\frac{1}{l'} & 1 + \lambda_A & \lambda_B & 0 & 0 \\ \frac{1}{l'} & -\frac{1}{l'} & \lambda_A & 1 + \lambda_B & 0 & 0 \\ 0 & 0 & 0 & 0 & 1 & 0 \\ 0 & 0 & 0 & 0 & 0 & 1 \end{bmatrix} \begin{Bmatrix} u_{zA} \\ u_{zB} \\ \theta_{yA} \\ \theta_{yB} \\ \delta_{xA} \\ \delta_{xB} \end{Bmatrix} = [\Lambda_B] \begin{Bmatrix} u_{zA} \\ u_{zB} \\ \theta_{yA} \\ \theta_{yB} \\ \delta_{xA} \\ \delta_{xB} \end{Bmatrix} \quad (2-1-10)$$

Out of plane deformation of beam

If we consider out-of-plane deformation of beam in case of flexible floor, as shown in Figure 2-1-4, the rotational displacement vector is,

$$\begin{Bmatrix} \theta'_{zA} \\ \theta'_{zB} \end{Bmatrix} = \begin{Bmatrix} \theta_{zA} - \tau \\ \theta_{zB} - \tau \end{Bmatrix}, \quad \tau = \frac{(u_{yA} - \lambda_A l' \theta_{zA}) - (u_{yB} + \lambda_B l' \theta_{zB})}{l'}$$

$$= \begin{Bmatrix} \theta_{zA} - \frac{1}{l'} u_{yA} + \lambda_A \theta_{zA} + \frac{1}{l'} u_{yB} + \lambda_B \theta_{zB} \\ \theta_{zB} - \frac{1}{l'} u_{yA} + \lambda_A \theta_{zA} + \frac{1}{l'} u_{yB} + \lambda_B \theta_{zB} \end{Bmatrix} = \begin{bmatrix} -\frac{1}{l'} & \frac{1}{l'} & 1 + \lambda_A & \lambda_B \\ -\frac{1}{l'} & \frac{1}{l'} & \lambda_A & 1 + \lambda_B \end{bmatrix} \begin{Bmatrix} u_{yA} \\ u_{yB} \\ \theta_{zA} \\ \theta_{zB} \end{Bmatrix} \quad (2-9-7)$$

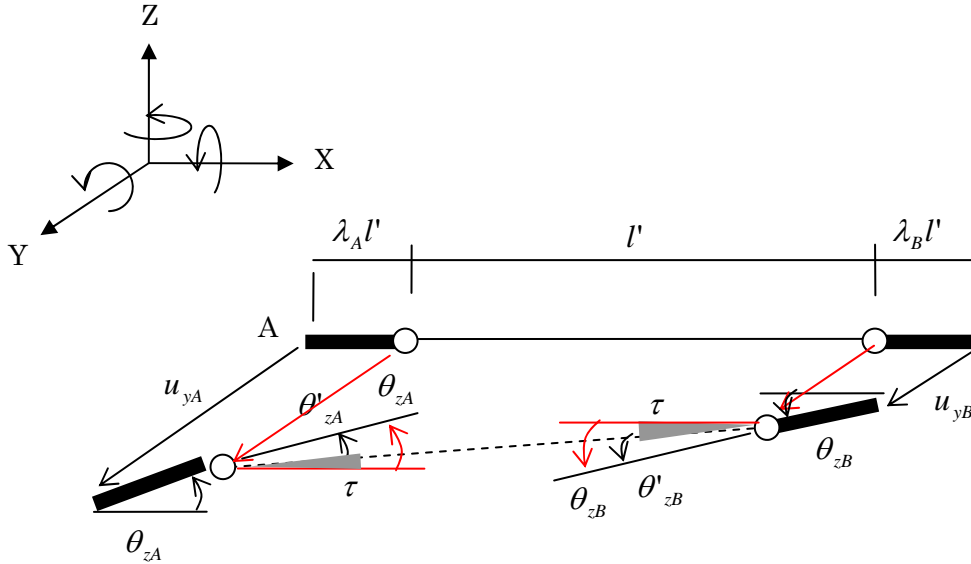

Figure 2-1-4 Beam displacement with rigid connection (X-Y plane)

$$\begin{Bmatrix} \theta'_{yA} \\ \theta'_{yB} \\ \theta'_{zA} \\ \theta'_{zB} \\ \delta_{xA} \\ \delta_{xB} \\ \theta_{xA} \\ \theta_{xB} \end{Bmatrix} = \begin{bmatrix} -\frac{1}{l'} & \frac{1}{l'} & 1 + \lambda_A & \lambda_B \\ -\frac{1}{l'} & \frac{1}{l'} & \lambda_A & 1 + \lambda_B \\ & & \frac{1}{l'} & -\frac{1}{l'} & 1 + \lambda_A & \lambda_B \\ & & \frac{1}{l'} & -\frac{1}{l'} & \lambda_A & 1 + \lambda_B \\ & & & & & & 1 \\ & & & & & & & 1 \end{bmatrix} \begin{Bmatrix} u_{zA} \\ u_{zB} \\ \theta_{yA} \\ \theta_{yB} \\ u_{yA} \\ u_{yB} \\ \theta_{zA} \\ \theta_{zB} \\ \delta_{xA} \\ \delta_{xB} \end{Bmatrix}$$

From global node displacement to element node displacement

Transformation from global node displacements to element node displacements is,

$$\begin{Bmatrix} u_{zA} \\ u_{zB} \\ \theta_{yA} \\ \theta_{yB} \\ \delta_{xA} \\ \delta_{xB} \end{Bmatrix} = [T_{ixB}] \begin{Bmatrix} u_1 \\ u_2 \\ \vdots \\ u_n \end{Bmatrix} \quad (2-1-11)$$

The component of the transformation matrix, $[T_{ixB}]$, is discussed in Chapter 4 (Freedom Vector).

From global node displacement to element face displacement

Transformation from the global node displacement to the element face displacement is,

$$\begin{Bmatrix} \theta'_{yA} \\ \theta'_{yB} \\ \delta'_{x} \end{Bmatrix} = [n_B][\Lambda_B][T_{ixB}] \begin{Bmatrix} u_1 \\ u_2 \\ \vdots \\ u_n \end{Bmatrix} = [T_{xB}] \begin{Bmatrix} u_1 \\ u_2 \\ \vdots \\ u_n \end{Bmatrix} \quad (2-1-12)$$

In case of Y-direction beam

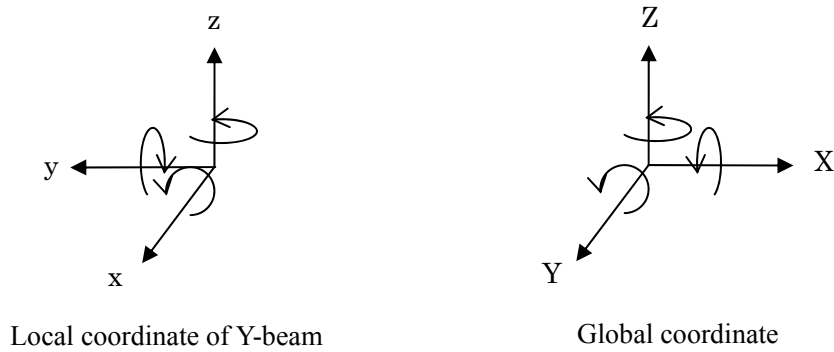

Figure 2-1-3 Relation between local coordinate and global coordinate

In case of Y-direction beam, the axial direction of the beam element coincides to the Y-axis in the global coordinate, transformation of the sign of the vector components of the element coordinate is,

$$\begin{Bmatrix} x \\ y \\ z \end{Bmatrix}_{Y\text{-Beam}} = \begin{bmatrix} 0 & 1 & 0 \\ -1 & 0 & 0 \\ 0 & 0 & 1 \end{bmatrix} \begin{Bmatrix} X \\ Y \\ Z \end{Bmatrix}_{Global} \quad (2-1-13)$$

Therefore

$$\begin{Bmatrix} u_{zA} \\ u_{zB} \\ \theta_{yA} \\ \theta_{yB} \\ \delta_{xA} \\ \delta_{xB} \end{Bmatrix}_{Y\text{-Beam}} = \begin{bmatrix} 1 & & & & & \\ & 1 & & & & \\ & & -1 & & & \\ & & & -1 & & \\ & & & & 1 & \\ & & & & & 1 \end{bmatrix} \begin{Bmatrix} u_{zA} \\ u_{zB} \\ \theta_{xA} \\ \theta_{xB} \\ \delta_{yA} \\ \delta_{yB} \end{Bmatrix}_{Global} = [S_B] \begin{Bmatrix} u_{zA} \\ u_{zB} \\ \theta_{xA} \\ \theta_{xB} \\ \delta_{yA} \\ \delta_{yB} \end{Bmatrix}_{Global} \quad (2-1-14)$$

Transformation from the global node displacement to the element node displacement is,

$$\begin{Bmatrix} u_{zA} \\ u_{zB} \\ \theta_{xA} \\ \theta_{xB} \\ \delta_{yA} \\ \delta_{yB} \end{Bmatrix} = [T_{iyB}] \begin{Bmatrix} u_1 \\ u_2 \\ \vdots \\ u_n \end{Bmatrix} \quad (2-1-15)$$

Transformation from the global node displacement to the element face displacement is,

$$\begin{Bmatrix} \theta'_{yA} \\ \theta'_{yB} \\ \delta'_x \end{Bmatrix} = [n_B] [\Lambda_B] [s_B] [T_{iyB}] \begin{Bmatrix} u_1 \\ u_2 \\ \vdots \\ u_n \end{Bmatrix} = [T_{yB}] \begin{Bmatrix} u_1 \\ u_2 \\ \vdots \\ u_n \end{Bmatrix} \quad (2-1-16)$$

Constitutive equation

Finally, the constitutive equation of the X-beam is,

$$\begin{Bmatrix} P_1 \\ P_2 \\ \vdots \\ P_n \end{Bmatrix} = [T_{xB}]^T [k_B] [T_{xB}] \begin{Bmatrix} u_1 \\ u_2 \\ \vdots \\ u_n \end{Bmatrix} = [K_{xB}] \begin{Bmatrix} u_1 \\ u_2 \\ \vdots \\ u_n \end{Bmatrix} \quad (2-1-17)$$

For Y-beam,

$$\begin{Bmatrix} P_1 \\ P_2 \\ \vdots \\ P_n \end{Bmatrix} = [T_{yB}]^T [k_B] [T_{yB}] \begin{Bmatrix} u_1 \\ u_2 \\ \vdots \\ u_n \end{Bmatrix} = [K_{yB}] \begin{Bmatrix} u_1 \\ u_2 \\ \vdots \\ u_n \end{Bmatrix} \quad (2-1-18)$$

Transformation matrix for nonlinear spring displacement

The nonlinear spring displacement vector is obtained from the element face displacement as,

$$\begin{Bmatrix} \phi_{yA} \\ \phi_{yB} \\ \eta_y \end{Bmatrix} = \begin{bmatrix} f_{yA} & 0 & 0 \\ 0 & f_{yB} & 0 \\ \frac{1}{k_{sz}l'} & \frac{1}{k_{sz}l'} & 0 \end{bmatrix} \begin{Bmatrix} M'_{yA} \\ M'_{yB} \\ N'_x \end{Bmatrix} = \begin{bmatrix} f_{yA} & 0 & 0 \\ 0 & f_{yB} & 0 \\ \frac{1}{k_{sz}l'} & \frac{1}{k_{sz}l'} & 0 \end{bmatrix} [k_B] \begin{Bmatrix} \theta'_{yA} \\ \theta'_{yB} \\ \delta'_x \end{Bmatrix} = [T_{pB}] \begin{Bmatrix} \theta'_{yA} \\ \theta'_{yB} \\ \delta'_x \end{Bmatrix} \quad (2-1-19)$$

where,

$$[T_{pB}] = \begin{bmatrix} f_{yA} & 0 & 0 \\ 0 & f_{yB} & 0 \\ \frac{1}{k_{sz}l'} & \frac{1}{k_{sz}l'} & 0 \end{bmatrix} [k_B] \quad (2-1-20)$$

3.2 Column

Element model for column is defined as a line element with nonlinear bending springs at both ends and two nonlinear shear springs in the middle of the element in x and y directions as shown in Figure 2-2-1.

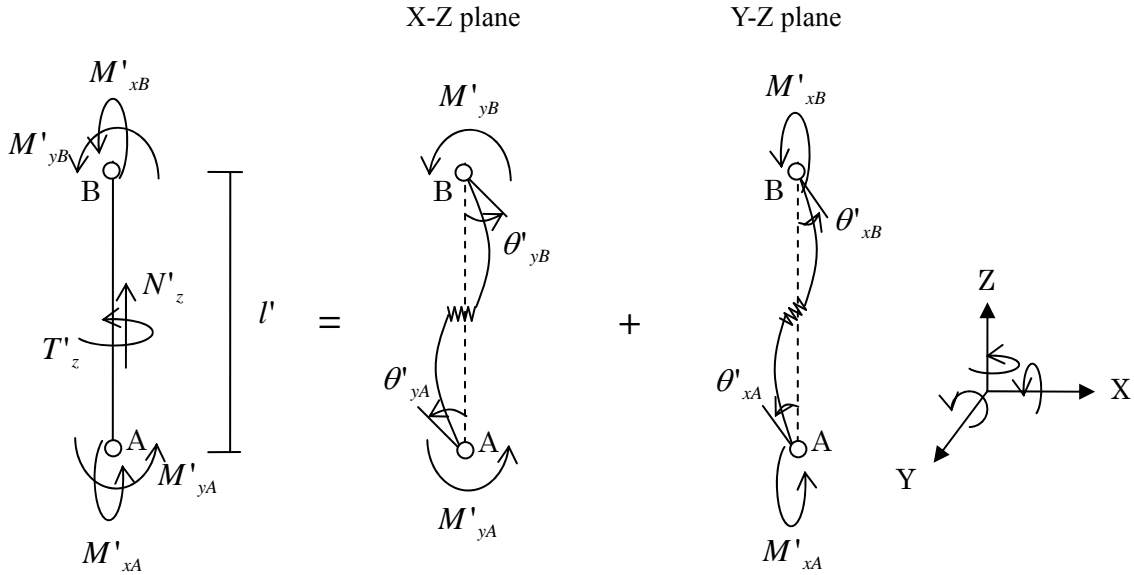

Figure 2-2-1 Element model for column

Force-displacement relationship for elastic element

In the same way as the beam element, the relationship between the displacement vector and force vector of the elastic element is,

$$\begin{Bmatrix} \tau'_{yA} \\ \tau'_{yB} \end{Bmatrix} = \begin{bmatrix} \frac{l'}{3EI_y} & -\frac{l'}{6EI_y} \\ -\frac{l'}{6EI_y} & \frac{l'}{3EI_y} \end{bmatrix} \begin{Bmatrix} M'_{yA} \\ M'_{yB} \end{Bmatrix} \quad \text{in X-Z plane} \quad (2-2-1)$$

$$\begin{Bmatrix} \tau'_{xA} \\ \tau'_{xB} \end{Bmatrix} = \begin{bmatrix} \frac{l'}{3EI_x} & -\frac{l'}{6EI_x} \\ -\frac{l'}{6EI_x} & \frac{l'}{3EI_x} \end{bmatrix} \begin{Bmatrix} M'_{xA} \\ M'_{xB} \end{Bmatrix} \quad \text{in Y-Z plane} \quad (2-2-2)$$

The axial displacement is,

$$\delta''_z = \frac{l'}{EA} N'_z \quad (2-2-3)$$

The torsion angle by torque force is,

$$\theta'_z = \frac{l'}{GI_z} T'_z \quad (2-2-4)$$

where, G and I_z are the shear modulus and the pole moment of inertia of the cross-sectional area.

Force-displacement relationship for nonlinear bending springs

Nonlinear interaction $M_x - M_y - N_z$ is considered in the nonlinear bending springs,

$$\begin{Bmatrix} \phi_{yA} \\ \phi_{xA} \\ \varepsilon_{zA} \end{Bmatrix} = [f_{pA}] \begin{Bmatrix} M'_{yA} \\ M'_{xA} \\ N'_{zA} \end{Bmatrix} \quad \text{at end A} \quad (2-2-5)$$

$$\begin{Bmatrix} \phi_{yB} \\ \phi_{xB} \\ \varepsilon_{zB} \end{Bmatrix} = [f_{pB}] \begin{Bmatrix} M'_{yB} \\ M'_{xB} \\ N'_{zB} \end{Bmatrix} \quad \text{at end B} \quad (2-2-6)$$

where, $[f_{pA}]$ and $[f_{pB}]$ are the flexural stiffness matrices of the nonlinear bending springs.

Therefore, the force-displacement relationship of nonlinear bending springs is,

$$\begin{Bmatrix} \phi_{yA} \\ \phi_{xA} \\ \varepsilon_{zA} \\ \phi_{yB} \\ \phi_{xB} \\ \varepsilon_{zB} \end{Bmatrix} = \begin{bmatrix} [f_{pA}] & 0 \\ 0 & [f_{pB}] \end{bmatrix} \begin{Bmatrix} M'_{yA} \\ M'_{xA} \\ N'_{zA} \\ M'_{yB} \\ M'_{xB} \\ N'_{zB} \end{Bmatrix} \quad (2-2-7)$$

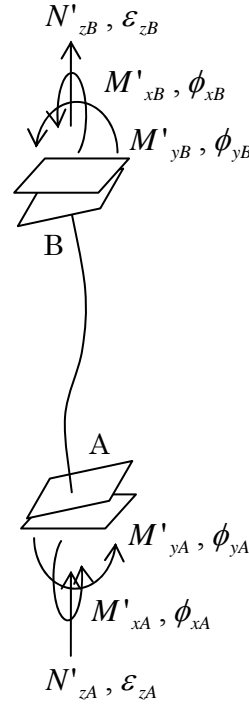

Figure 2-2-2 Nonlinear bending springs

Rearrange the order of the components of the displacement vector and change the node axial displacements into the relative axial displacement,

$$\begin{Bmatrix} \phi_{yA} \\ \phi_{yB} \\ \phi_{xA} \\ \phi_{xB} \\ \varepsilon_z \end{Bmatrix} = \begin{bmatrix} 1 & 0 & 0 & 0 & 0 & 0 \\ 0 & 0 & 0 & 1 & 0 & 0 \\ 0 & 1 & 0 & 0 & 0 & 0 \\ 0 & 0 & 0 & 0 & 1 & 0 \\ 0 & 0 & -1 & 0 & 0 & 1 \end{bmatrix} \begin{Bmatrix} \phi_{yA} \\ \phi_{xA} \\ \varepsilon_{zA} \\ \phi_{yB} \\ \phi_{xB} \\ \varepsilon_{zB} \end{Bmatrix} = [n_p] \begin{Bmatrix} \phi_{yA} \\ \phi_{xA} \\ \varepsilon_{zA} \\ \phi_{yB} \\ \phi_{xB} \\ \varepsilon_{zB} \end{Bmatrix} \quad (2-2-8)$$

The force-displacement relationship in Equation (2-2-7) is then expressed as,

$$\begin{Bmatrix} \phi_{yA} \\ \phi_{yB} \\ \phi_{xA} \\ \phi_{xB} \\ \varepsilon_z \end{Bmatrix} = [n_p] \begin{bmatrix} [f_{pA}] & 0 \\ 0 & [f_{pB}] \end{bmatrix} [n_p]^T \begin{Bmatrix} M'_{yA} \\ M'_{yB} \\ M'_{xA} \\ M'_{xB} \\ N'_z \end{Bmatrix} = [f_p] \begin{Bmatrix} M'_{yA} \\ M'_{yB} \\ M'_{xA} \\ M'_{xB} \\ N'_z \end{Bmatrix} \quad (2-2-9)$$

Force-displacement relationship for nonlinear shear springs

The rotational displacement vector from the shear deformation of the nonlinear shear spring is,

$$\begin{Bmatrix} \eta_{yA} \\ \eta_{yB} \end{Bmatrix} = \begin{bmatrix} 1 & 1 \\ \frac{1}{k_{sx} l'} & \frac{1}{k_{sx} l'} \\ 1 & 1 \\ \frac{1}{k_{sx} l'} & \frac{1}{k_{sx} l'} \end{bmatrix} \begin{Bmatrix} M'_{yA} \\ M'_{yB} \end{Bmatrix} \quad \text{in X-Z plane} \quad (2-2-10)$$

$$\begin{Bmatrix} \eta_{xA} \\ \eta_{xB} \end{Bmatrix} = \begin{bmatrix} 1 & 1 \\ \frac{1}{k_{sy} l'} & \frac{1}{k_{sy} l'} \\ 1 & 1 \\ \frac{1}{k_{sy} l'} & \frac{1}{k_{sy} l'} \end{bmatrix} \begin{Bmatrix} M'_{xA} \\ M'_{xB} \end{Bmatrix} \quad \text{in Y-Z plane} \quad (2-2-11)$$

where, k_{sx} and k_{sy} are the shear stiffness of the nonlinear shear springs.

The displacement vector of the column element is obtained as the sum of the displacement vectors of elastic element, nonlinear shear springs and nonlinear bending springs,

$$\begin{Bmatrix} \theta'_{yA} \\ \theta'_{yB} \\ \theta'_{xA} \\ \theta'_{xB} \\ \delta'_z \\ \theta'_z \end{Bmatrix} = \underbrace{\begin{Bmatrix} \tau'_{yA} \\ \tau'_{yB} \\ \tau'_{xA} \\ \tau'_{xB} \\ \delta''_z \\ \theta'_z \end{Bmatrix}}_{\text{elastic element}} + \underbrace{\begin{Bmatrix} \phi_{yA} \\ \phi_{yB} \\ \phi_{xA} \\ \phi_{xB} \\ \varepsilon_z \\ 0 \end{Bmatrix}}_{\text{bending spring}} + \underbrace{\begin{Bmatrix} \eta_{yA} \\ \eta_{yB} \\ \eta_{xA} \\ \eta_{xB} \\ 0 \\ 0 \end{Bmatrix}}_{\text{shear spring}} = [f_C] \begin{Bmatrix} M'_{yA} \\ M'_{yB} \\ M'_{xA} \\ M'_{xB} \\ N'_z \\ T'_z \end{Bmatrix} \quad (2-2-12)$$

The flexural matrix $[f_C]$ is;

$$[f_C] = \begin{bmatrix} \frac{l'}{3EI_y} & -\frac{l'}{6EI_y} & & & & & \\ & \frac{l'}{3EI_y} & & & & & \\ & & \frac{l'}{3EI_x} & -\frac{l'}{6EI_x} & & & \\ & & & \frac{l'}{3EI_x} & & & \\ & & & & \frac{l'}{EA} & & \\ & & & & & \frac{l'}{GI_z} & \\ \text{sym.} & & & & & & \text{elastic element} \end{bmatrix} +$$

$$\begin{bmatrix} f_{p11} & f_{p12} & f_{p13} & f_{p14} & f_{p15} & 0 \\ & f_{p22} & f_{p23} & f_{p24} & f_{p25} & 0 \\ & & f_{p33} & f_{p34} & f_{p35} & 0 \\ & & & f_{p44} & f_{p45} & 0 \\ & & & & f_{p55} & 0 \\ \text{sym.} & & & & & 0 \end{bmatrix} \text{bending spring} +
\begin{bmatrix} \frac{1}{k_{sx}l'} & \frac{1}{k_{sx}l'} & & & & \\ & \frac{1}{k_{sx}l'} & & & & 0 \\ & & \frac{1}{k_{sy}l'} & \frac{1}{k_{sy}l'} & & \\ & & & \frac{1}{k_{sy}l'} & & \\ \text{sym.} & & & & & 0 \end{bmatrix} \text{shear spring} \quad (2-2-13)$$

By taking the inverse matrix of $[f_C]$, the constitutive equation of the column element is obtained as,

$$\begin{Bmatrix} M'_{yA} \\ M'_{yB} \\ M'_{xA} \\ M'_{xB} \\ N'_z \\ T'_z \end{Bmatrix} = [f_C]^{-1} \begin{Bmatrix} \theta'_{yA} \\ \theta'_{yB} \\ \theta'_{xA} \\ \theta'_{xB} \\ \delta'_z \\ \theta'_z \end{Bmatrix} = [k_C] \begin{Bmatrix} \theta'_{yA} \\ \theta'_{yB} \\ \theta'_{xA} \\ \theta'_{xB} \\ \delta'_z \\ \theta'_z \end{Bmatrix} \quad (2-2-14)$$

Including rigid parts and node movement

Change relative axial displacement and torsion displacement into node displacement,

$$\begin{Bmatrix} \theta'_{yA} \\ \theta'_{yB} \\ \theta'_{xA} \\ \theta'_{xB} \\ \delta'_z \\ \theta'_z \end{Bmatrix} = \begin{bmatrix} 1 & & & & & \\ & 1 & & & & 0 \\ & & 1 & & & \\ & & & 1 & & \\ & 0 & & -1 & 1 & \\ & & & & -1 & 1 \end{bmatrix} \begin{Bmatrix} \theta'_{yA} \\ \theta'_{yB} \\ \theta'_{xA} \\ \theta'_{xB} \\ \delta_{zA} \\ \delta_{zB} \\ \theta_{zA} \\ \theta_{zB} \end{Bmatrix} = [n_C] \begin{Bmatrix} \theta'_{yA} \\ \theta'_{yB} \\ \theta'_{xA} \\ \theta'_{xB} \\ \delta_{zA} \\ \delta_{zB} \\ \theta_{zA} \\ \theta_{zB} \end{Bmatrix} \quad (2-2-15)$$

Including rigid parts and node movement,

$$\begin{Bmatrix} \theta'_{yA} \\ \theta'_{yB} \\ \theta'_{xA} \\ \theta'_{xB} \\ \delta_{zA} \\ \delta_{zB} \\ \theta_{zA} \\ \theta_{zB} \end{Bmatrix} = \begin{bmatrix} -\frac{1}{l'} & \frac{1}{l'} & 1+\lambda_A & \lambda_B & & & & \\ -\frac{1}{l'} & \frac{1}{l'} & \lambda_A & 1+\lambda_B & & & & \\ & & & & \frac{1}{l'} & -\frac{1}{l'} & 1+\lambda_A & \lambda_B \\ & & & & \frac{1}{l'} & -\frac{1}{l'} & \lambda_A & 1+\lambda_B \\ & & & & & & & & 1 \\ & & & & & & & & & 1 \\ & & & & & & & & & & 1 \\ & & & & & & & & & & & 1 \end{bmatrix} \begin{Bmatrix} u_{xA} \\ u_{xB} \\ \theta_{yA} \\ \theta_{yB} \\ u_{yA} \\ u_{yB} \\ \theta_{xA} \\ \theta_{xB} \\ \delta_{zA} \\ \delta_{zB} \\ \theta_{zA} \\ \theta_{zB} \end{Bmatrix} = [\Lambda_C] \begin{Bmatrix} u_{xA} \\ u_{xB} \\ \theta_{yA} \\ \theta_{yB} \\ u_{yA} \\ u_{yB} \\ \theta_{xA} \\ \theta_{xB} \\ \delta_{zA} \\ \delta_{zB} \\ \theta_{zA} \\ \theta_{zB} \end{Bmatrix}$$

(2-2-16)

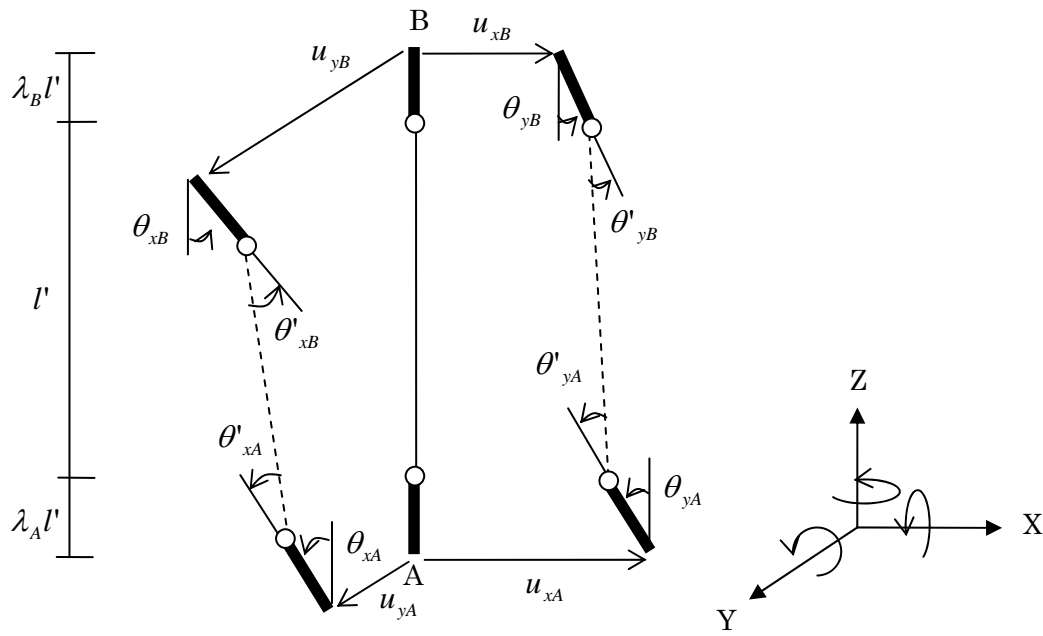

Figure 2-2-3 Including rigid parts and node movement

From global node displacement to element node displacement

Transformation from global node displacement to element node displacement is;

$$\begin{Bmatrix} u_{xA} \\ u_{xB} \\ \theta_{yA} \\ \theta_{yB} \\ u_{yA} \\ u_{yB} \\ \theta_{xA} \\ \theta_{xB} \\ \delta_{zA} \\ \delta_{zB} \\ \theta_{zA} \\ \theta_{zB} \end{Bmatrix} = [T_{iC}] \begin{Bmatrix} u_1 \\ u_2 \\ \vdots \\ u_n \end{Bmatrix} \quad (2-2-17)$$

The component of the transformation matrix, $[T_{iC}]$, is discussed in Chapter 4 (Freedom Vector).

From global node displacement to element face displacement

Transformation from the global node displacement to the element face displacement is,

$$\begin{Bmatrix} \theta'_{yA} \\ \theta'_{yB} \\ \theta'_{xA} \\ \theta'_{xB} \\ \delta'_z \\ \theta'_z \end{Bmatrix} = [n_c] [\Lambda_c] [T_{iC}] \begin{Bmatrix} u_1 \\ u_2 \\ \vdots \\ u_n \end{Bmatrix} = [T_C] \begin{Bmatrix} u_1 \\ u_2 \\ \vdots \\ u_n \end{Bmatrix} \quad (2-2-18)$$

Constitutive equation

Finally, the constitutive equation of the column is;

$$\begin{Bmatrix} P_1 \\ P_2 \\ \vdots \\ P_n \end{Bmatrix} = [K_C] \begin{Bmatrix} u_1 \\ u_2 \\ \vdots \\ u_n \end{Bmatrix} \quad (2-2-19)$$

where,

$$[K_C] = [T_C]^T [k_C] [T_C] \quad (2-2-20)$$

Transformation matrix for nonlinear spring displacement

The nonlinear spring displacement vector is obtained from Equations (2-2-7), (2-2-10) and (2-2-11),

$$\begin{Bmatrix} \phi_{yA} \\ \phi_{xA} \\ \varepsilon_{zA} \\ \phi_{yB} \\ \phi_{xB} \\ \varepsilon_{zB} \\ \eta_y \\ \eta_x \end{Bmatrix} = \begin{bmatrix} & [f_{pA}] & & & & & & \\ & & & & & & & 0 \\ & & & & & & & \\ & 0 & & & [f_{pA}] & & & \\ & & & & & & & \\ \frac{1}{k_{sx}l'} & 0 & 0 & \frac{1}{k_{sx}l'} & 0 & 0 & & \\ 0 & \frac{1}{k_{sy}l'} & 0 & 0 & \frac{1}{k_{sy}l'} & 0 & & \end{bmatrix} \begin{Bmatrix} M'_{yA} \\ M'_{xA} \\ N'_{zA} \\ M'_{yB} \\ M'_{xB} \\ N'_{zB} \end{Bmatrix} = [f_{pC}] \begin{Bmatrix} M'_{yA} \\ M'_{xA} \\ N'_{zA} \\ M'_{yB} \\ M'_{xB} \\ N'_{zB} \end{Bmatrix} \quad (2-2-21)$$

Furthermore, in the same way as Equation (2-2-8),

$$\begin{Bmatrix} M'_{yA} \\ M'_{xA} \\ N'_{zA} \\ M'_{yB} \\ M'_{xB} \\ N'_{zB} \end{Bmatrix} = [n_p]^T \{0\} \begin{Bmatrix} M'_{yA} \\ M'_{yB} \\ M'_{xA} \\ M'_{xB} \\ N'_z \\ T'_z \end{Bmatrix} = [n'_p] \begin{Bmatrix} M'_{yA} \\ M'_{yB} \\ M'_{xA} \\ M'_{xB} \\ N'_z \\ T'_z \end{Bmatrix} \quad (2-2-22)$$

Therefore, the nonlinear spring displacement vector is obtained from the element face displacement as,

$$\begin{Bmatrix} \phi_{yA} \\ \phi_{xA} \\ \varepsilon_{zA} \\ \phi_{yB} \\ \phi_{xB} \\ \varepsilon_{zB} \\ \eta_y \\ \eta_x \end{Bmatrix} = [f_{pC}] [n'_p] \begin{Bmatrix} M'_{yA} \\ M'_{yB} \\ M'_{xA} \\ M'_{xB} \\ N'_z \\ T'_z \end{Bmatrix} = [f_{pC}] [n'_p] [k_C] \begin{Bmatrix} \theta'_{yA} \\ \theta'_{yB} \\ \theta'_{xA} \\ \theta'_{xB} \\ \delta'_z \\ \theta'_z \end{Bmatrix} = [T_{pC}] \begin{Bmatrix} \theta'_{yA} \\ \theta'_{yB} \\ \theta'_{xA} \\ \theta'_{xB} \\ \delta'_z \\ \theta'_z \end{Bmatrix} \quad (2-2-23)$$

2.3 Wall

Element model for wall is defined as a line element with nonlinear bending springs at both ends and three nonlinear shear springs; one is in the middle of the wall panel and others are in the side columns as shown in Figure 2-3-1.

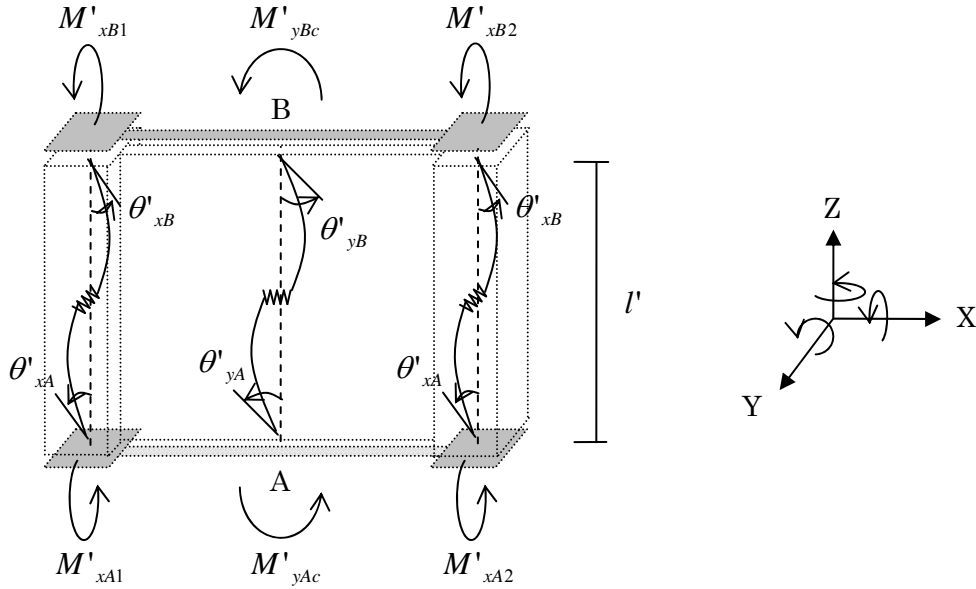

Figure 2-3-1 Element model for wall

Force-displacement relationship for elastic element

In the same way as the beam element, the relationship between the displacement vector and force vector of the elastic element is,

$$\begin{Bmatrix} \tau'_{yAc} \\ \tau'_{yBc} \end{Bmatrix} = \begin{bmatrix} \frac{l'}{3EI_c} & -\frac{l'}{6EI_c} \\ -\frac{l'}{6EI_c} & \frac{l'}{3EI_c} \end{bmatrix} \begin{Bmatrix} M'_{yAc} \\ M'_{yBc} \end{Bmatrix} \quad \text{in wall panel} \quad (2-3-1)$$

$$\begin{Bmatrix} \tau'_{xA1} \\ \tau'_{xB1} \end{Bmatrix} = \begin{bmatrix} \frac{l'}{3EI_1} & -\frac{l'}{6EI_1} \\ -\frac{l'}{6EI_1} & \frac{l'}{3EI_1} \end{bmatrix} \begin{Bmatrix} M'_{xA1} \\ M'_{xB1} \end{Bmatrix} \quad \text{in side column 1} \quad (2-3-2)$$

$$\begin{Bmatrix} \tau'_{xA2} \\ \tau'_{xB2} \end{Bmatrix} = \begin{bmatrix} \frac{l'}{3EI_2} & -\frac{l'}{6EI_2} \\ -\frac{l'}{6EI_2} & \frac{l'}{3EI_2} \end{bmatrix} \begin{Bmatrix} M'_{xA2} \\ M'_{xB2} \end{Bmatrix} \quad \text{in side column 2} \quad (2-3-3)$$

The axial displacement is,

$$\delta''_{zc} = \frac{l'}{EA} N'_{zc} \quad (2-3-4)$$

Force-displacement relationship for nonlinear bending springs

Nonlinear interaction $M_x - M_y - N_z$ is considered in the nonlinear bending springs,

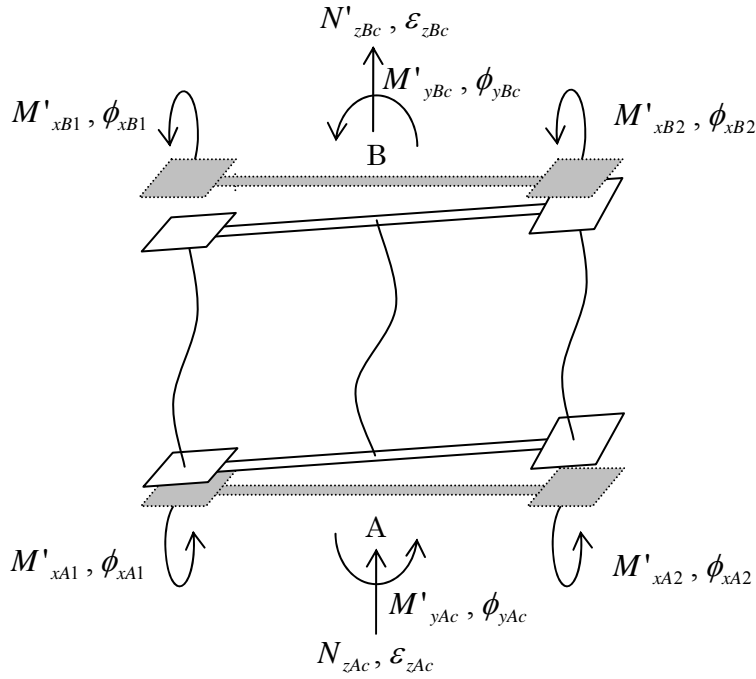

Figure 2-3-2 Nonlinear bending springs

$$\begin{Bmatrix} \phi_{yAc} \\ \phi_{xA1} \\ \phi_{xA2} \\ \epsilon_{zAc} \end{Bmatrix} = [f_{pA}] \begin{Bmatrix} M'_{yAc} \\ M'_{xA1} \\ M'_{xA2} \\ N'_{zAc} \end{Bmatrix} \text{ at end A} \quad (2-3-5)$$

$$\begin{Bmatrix} \phi_{yBc} \\ \phi_{xB1} \\ \phi_{xB2} \\ \epsilon_{zBc} \end{Bmatrix} = [f_{pB}] \begin{Bmatrix} M'_{yBc} \\ M'_{xB1} \\ M'_{xB2} \\ N'_{zBc} \end{Bmatrix} \text{ at end B} \quad (2-3-6)$$

where, $[f_{pA}]$ and $[f_{pB}]$ are the flexural stiffness matrices of the nonlinear bending springs. Therefore, the force-displacement relationship of nonlinear bending springs is,

$$\begin{Bmatrix} \phi_{yAc} \\ \phi_{xA1} \\ \phi_{xA2} \\ \varepsilon_{zAc} \\ \phi_{yBc} \\ \phi_{xB1} \\ \phi_{xB2} \\ \varepsilon_{zBc} \end{Bmatrix} = \begin{bmatrix} [f_{pA}] & 0 \\ 0 & [f_{pB}] \end{bmatrix} \begin{Bmatrix} M'_{yAc} \\ M'_{xA1} \\ M'_{xA2} \\ N'_{zAc} \\ M'_{yBc} \\ M'_{xB1} \\ M'_{xB2} \\ N'_{zBc} \end{Bmatrix} \quad (2-3-7)$$

Rearrange the order of the components of the displacement vector and change the node axial displacements into the relative axial displacement,

$$\begin{Bmatrix} \phi_{yAc} \\ \phi_{yBc} \\ \phi_{xA1} \\ \phi_{xB1} \\ \phi_{xA2} \\ \phi_{xB2} \\ \varepsilon_{zc} \end{Bmatrix} = \begin{bmatrix} 1 & & & & & & \\ & & 1 & & & & \\ & 1 & & & & & \\ & & & 1 & & & \\ & & 1 & & & & \\ & & & & 1 & & \\ & & & -1 & & 1 & \end{bmatrix} \begin{Bmatrix} \phi_{yAc} \\ \phi_{xA1} \\ \phi_{xA2} \\ \varepsilon_{zAc} \\ \phi_{yBc} \\ \phi_{xB1} \\ \phi_{xB2} \\ \varepsilon_{zBc} \end{Bmatrix} = [n_p] \begin{Bmatrix} \phi_{yAc} \\ \phi_{xA1} \\ \phi_{xA2} \\ \varepsilon_{zAc} \\ \phi_{yBc} \\ \phi_{xB1} \\ \phi_{xB2} \\ \varepsilon_{zBc} \end{Bmatrix} \quad (2-3-8)$$

The force-displacement relationship in Equation (2-3-7) is then expressed as,

$$\begin{Bmatrix} \phi_{yAc} \\ \phi_{yBc} \\ \phi_{xA1} \\ \phi_{xB1} \\ \phi_{xA2} \\ \phi_{xB2} \\ \varepsilon_{zc} \end{Bmatrix} = [n_p] \begin{bmatrix} [f_{pA}] & 0 \\ 0 & [f_{pB}] \end{bmatrix} [n_p]^T \begin{Bmatrix} M'_{yAc} \\ M'_{yBc} \\ M'_{xA1} \\ M'_{xB1} \\ M'_{xA2} \\ M'_{xB2} \\ N'_{zc} \end{Bmatrix} = [f_p] \begin{Bmatrix} M'_{yAc} \\ M'_{yBc} \\ M'_{xA1} \\ M'_{xB1} \\ M'_{xA2} \\ M'_{xB2} \\ N'_{zc} \end{Bmatrix} \quad (2-3-9)$$

Force-displacement relationship for nonlinear shear springs

The rotational displacement vector from the shear deformation of the nonlinear shear spring is,

$$\begin{Bmatrix} \eta_{yAc} \\ \eta_{yBc} \end{Bmatrix} = \begin{bmatrix} \frac{1}{k_{sc}l'} & \frac{1}{k_{sc}l'} \\ \frac{1}{k_{sc}l'} & \frac{1}{k_{sc}l'} \end{bmatrix} \begin{Bmatrix} M'_{yAc} \\ M'_{yBc} \end{Bmatrix} \quad \text{in wall panel} \quad (2-3-10)$$

$$\begin{Bmatrix} \eta_{xA1} \\ \eta_{xB1} \end{Bmatrix} = \begin{bmatrix} \frac{1}{k_{s1}l'} & \frac{1}{k_{s1}l'} \\ \frac{1}{k_{s1}l'} & \frac{1}{k_{s1}l'} \end{bmatrix} \begin{Bmatrix} M'_{xA1} \\ M'_{xB1} \end{Bmatrix} \quad \text{in side column 1} \quad (2-3-11)$$

$$\begin{Bmatrix} \eta_{xA2} \\ \eta_{xB2} \end{Bmatrix} = \begin{bmatrix} \frac{1}{k_{s2}l'} & \frac{1}{k_{s2}l'} \\ \frac{1}{k_{s2}l'} & \frac{1}{k_{s2}l'} \end{bmatrix} \begin{Bmatrix} M'_{xA2} \\ M'_{xB2} \end{Bmatrix} \quad \text{in side column 2} \quad (2-3-12)$$

where, k_{sc} , k_{s1} and k_{s2} are the shear stiffness of the nonlinear shear springs.

The displacement vector of the column element is obtained as the sum of the displacement vectors of elastic element, nonlinear shear springs and nonlinear bending springs,

$$\begin{Bmatrix} \theta'_{yAc} \\ \theta'_{yBc} \\ \theta'_{xA1} \\ \theta'_{xB1} \\ \theta'_{xA2} \\ \theta'_{xB2} \\ \delta'_{zc} \end{Bmatrix} = \underbrace{\begin{Bmatrix} \tau'_{yAc} \\ \tau'_{yBc} \\ \tau'_{xA1} \\ \tau'_{xB1} \\ \tau'_{xA2} \\ \tau'_{xB2} \\ \delta''_{zc} \end{Bmatrix}}_{\text{elastic element}} + \underbrace{\begin{Bmatrix} \phi_{yAc} \\ \phi_{yBc} \\ \phi_{xA1} \\ \phi_{xB1} \\ \phi_{xA2} \\ \phi_{xB2} \\ \varepsilon_{zc} \end{Bmatrix}}_{\text{bending spring}} + \underbrace{\begin{Bmatrix} \eta_{yAc} \\ \eta_{yBc} \\ \eta_{xA1} \\ \eta_{xB1} \\ \eta_{xA2} \\ \eta_{xB2} \\ 0 \end{Bmatrix}}_{\text{shear spring}} = [f_w] \begin{Bmatrix} M'_{yAc} \\ M'_{yBc} \\ M'_{xA1} \\ M'_{xB1} \\ M'_{xA2} \\ M'_{xB2} \\ N'_{zc} \end{Bmatrix} \quad (2-3-13)$$

The flexural matrix $[f_w]$ is;

$$[f_w] = \begin{bmatrix} \frac{l'}{3EI_c} & -\frac{l'}{6EI_c} & & & & & \\ & \frac{l'}{3EI_c} & & & & & \\ & & \frac{l'}{3EI_1} & -\frac{l'}{6EI_1} & & & \\ & & & \frac{l'}{3EI_1} & & & \\ & & & & \frac{l'}{3EI_2} & -\frac{l'}{6EI_2} & \\ & & & & & \frac{l'}{3EI_2} & \\ & \text{sym.} & & & & & \frac{l'}{EA_c} \end{bmatrix}_{\text{elastic element}} + \begin{bmatrix} f_{p11} & \cdots & f_{p17} \\ \vdots & & \vdots \\ f_{p71} & \cdots & f_{p77} \end{bmatrix}_{\text{bending spring}}$$

$$\left[\begin{array}{cccccc}
\frac{1}{k_{sc}l'} & \frac{1}{k_{sc}l'} & & & & \\
& \frac{1}{k_{sc}l'} & & & & \\
& & \frac{1}{k_{s1}l'} & \frac{1}{k_{s1}l'} & & \\
& & & \frac{1}{k_{s1}l'} & & \\
& & & & \frac{1}{k_{s2}l'} & \frac{1}{k_{s2}l'} \\
& & & & & \frac{1}{k_{s2}l'} \\
sym. & & & & & \\
& & & & & 0
\end{array} \right]_{shear\ spring}
\tag{2-3-14}$$

By taking the inverse matrix of $[f_w]$, the constitutive equation of the column element is obtained as,

$$\left\{ \begin{array}{c} M'_{yAc} \\ M'_{yBc} \\ M'_{xA1} \\ M'_{xB1} \\ M'_{xA2} \\ M'_{xB2} \\ N'_{zc} \end{array} \right\} = [f_w]^{-1} \left\{ \begin{array}{c} \theta'_{yAc} \\ \theta'_{yBc} \\ \theta'_{xA1} \\ \theta'_{xB1} \\ \theta'_{xA2} \\ \theta'_{xB2} \\ \delta'_{zc} \end{array} \right\} = [k_w] \left\{ \begin{array}{c} \theta'_{yAc} \\ \theta'_{yBc} \\ \theta'_{xA1} \\ \theta'_{xB1} \\ \theta'_{xA2} \\ \theta'_{xB2} \\ \delta'_{zc} \end{array} \right\}
\tag{2-3-15}$$

Including rigid parts and node movement

Change relative axial displacement and torsion displacement into node displacement,

$$\left\{ \begin{array}{c} \theta'_{yAc} \\ \theta'_{yBc} \\ \theta'_{xA1} \\ \theta'_{xB1} \\ \theta'_{xA2} \\ \theta'_{xB2} \\ \delta'_{zc} \end{array} \right\} = \left[\begin{array}{cccccc}
1 & & & & & \\
& 1 & & & & \\
& & 1 & & & \\
& & & 1 & & \\
& & & & 1 & \\
& & & & & 1 \\
& & & & & -1 & 1
\end{array} \right] \left\{ \begin{array}{c} \theta'_{yAc} \\ \theta'_{yBc} \\ \theta'_{xA1} \\ \theta'_{xB1} \\ \theta'_{xA2} \\ \theta'_{xB2} \\ \delta'_{zAc} \\ \delta'_{zBc} \end{array} \right\} = [n_w] \left\{ \begin{array}{c} \theta'_{yAc} \\ \theta'_{yBc} \\ \theta'_{xA1} \\ \theta'_{xB1} \\ \theta'_{xA2} \\ \theta'_{xB2} \\ \delta'_{zAc} \\ \delta'_{zBc} \end{array} \right\}
\tag{2-3-16}$$

Including rigid parts and node movement,

$$\begin{Bmatrix} \theta'_{yAc} \\ \theta'_{yBc} \\ \theta'_{xA1} \\ \theta'_{xB1} \\ \theta'_{xA2} \\ \theta'_{xB2} \\ \delta'_{zAc} \\ \delta'_{zBc} \end{Bmatrix} = \begin{bmatrix} -\frac{1}{l'} & \frac{1}{l'} & 1+\lambda_A & \lambda_B & & & & & \\ -\frac{1}{l'} & \frac{1}{l'} & \lambda_A & 1+\lambda_B & & & & & \\ & & \frac{1}{l'} & -\frac{1}{l'} & 1+\lambda_A & \lambda_B & & & \\ & & \frac{1}{l'} & -\frac{1}{l'} & \lambda_A & 1+\lambda_B & & & \\ & & & & \frac{1}{l'} & -\frac{1}{l'} & 1+\lambda_A & \lambda_B & \\ & & & & \frac{1}{l'} & -\frac{1}{l'} & \lambda_A & 1+\lambda_B & \\ & & & & & & & & 1 \\ & & & & & & & & & 1 \end{bmatrix} \begin{Bmatrix} u_{xAc} \\ u_{xBc} \\ \theta_{yAc} \\ \theta_{yBc} \\ u_{yA1} \\ u_{yB1} \\ \theta_{xA1} \\ \theta_{xB1} \\ u_{yA2} \\ u_{yB2} \\ \theta_{xA2} \\ \theta_{xB2} \\ \delta_{zAc} \\ \delta_{zBc} \end{Bmatrix} = [\Lambda_w] \begin{Bmatrix} u_{xAc} \\ u_{xBc} \\ \theta_{yAc} \\ \theta_{yBc} \\ u_{yA1} \\ u_{yB1} \\ \theta_{xA1} \\ \theta_{xB1} \\ u_{yA2} \\ u_{yB2} \\ \theta_{xA2} \\ \theta_{xB2} \\ \delta_{zAc} \\ \delta_{zBc} \end{Bmatrix} \quad (2-3-17)$$

From global node displacement to element node displacement

Transformation from the center displacements to the node displacements is,

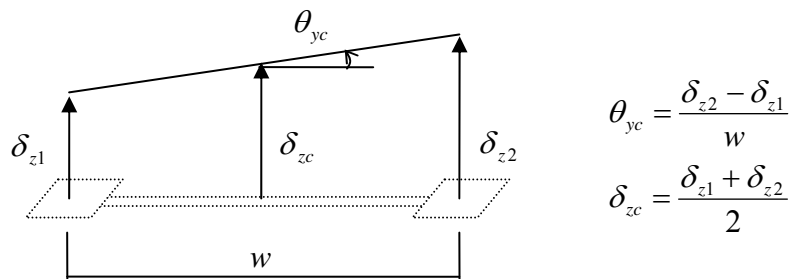

Figure 2-3-3 Relationship between center and node displacements

$$\begin{Bmatrix} u_{xAc} \\ u_{xBc} \\ \theta_{yAc} \\ \theta_{yBc} \\ u_{yA1} \\ u_{yB1} \\ \theta_{xA1} \\ \theta_{xB1} \\ u_{yA2} \\ u_{yB2} \\ \theta_{xA2} \\ \theta_{xB2} \\ \delta_{zAc} \\ \delta_{zBc} \end{Bmatrix} = \begin{bmatrix} 1 & & & & & & & & & & & & & & \\ & -\frac{1}{w} & \frac{1}{w} & & & & & & & & & & & & \\ & & & -\frac{1}{w} & \frac{1}{w} & & & & & & & & & & \\ & & & & & 1 & & & & & & & & & \\ & & & & & & 1 & & & & & & & & \\ & & & & & & & 1 & & & & & & & \\ & & & & & & & & 1 & & & & & & \\ & & & & & & & & & 1 & & & & & \\ & & & & & & & & & & 1 & & & & \\ & & & & & & & & & & & 1 & & & \\ & & & & & & & & & & & & 1 & & \\ & 0.5 & 0.5 & & & & & & & & & & & & \\ & & & 0.5 & 0.5 & & & & & & & & & & \end{bmatrix} \begin{Bmatrix} u_{xA1} \\ \delta_{zA1} \\ \delta_{zA2} \\ u_{xB1} \\ \delta_{zB1} \\ \delta_{zB2} \\ u_{yA1} \\ u_{yB1} \\ \theta_{xA1} \\ \theta_{xB1} \\ u_{yA2} \\ u_{yB2} \\ \theta_{xA2} \\ \theta_{xB2} \end{Bmatrix} = [D_w] \begin{Bmatrix} u_{xA1} \\ \delta_{zA1} \\ \delta_{zA2} \\ u_{xB1} \\ \delta_{zB1} \\ \delta_{zB2} \\ u_{yA1} \\ u_{yB1} \\ \theta_{xA1} \\ \theta_{xB1} \\ u_{yA2} \\ u_{yB2} \\ \theta_{xA2} \\ \theta_{xB2} \end{Bmatrix} \quad (2-3-18)$$

Transformation from the global node displacements to the element node displacements is;

$$\begin{Bmatrix} u_{xA1} \\ \delta_{zA1} \\ \delta_{zA2} \\ u_{xB1} \\ \delta_{zB1} \\ \delta_{zB2} \\ u_{yA1} \\ u_{yB1} \\ \theta_{xA1} \\ \theta_{xB1} \\ u_{yA2} \\ u_{yB2} \\ \theta_{xA2} \\ \theta_{xB2} \end{Bmatrix} = [T_{ixW}] \begin{Bmatrix} u_1 \\ u_2 \\ \vdots \\ u_n \end{Bmatrix} \quad (2-3-19)$$

The component of the transformation matrix, $[T_{ixW}]$, is discussed in Chapter 4 (Freedom Vector).

From global node displacement to element face displacement

Transformation from the global node displacement to the element face displacement is,

$$\begin{Bmatrix} \theta'_{yAc} \\ \theta'_{yBc} \\ \theta'_{xA1} \\ \theta'_{xB1} \\ \theta'_{xA2} \\ \theta'_{xB2} \\ \delta'_{zc} \end{Bmatrix} = [n_w] [\Lambda_w] [D_w] [T_{ixW}] \begin{Bmatrix} u_1 \\ u_2 \\ \vdots \\ u_n \end{Bmatrix} = [T_{xw}] \begin{Bmatrix} u_1 \\ u_2 \\ \vdots \\ u_n \end{Bmatrix} \quad (2-3-20)$$

In case of Y-direction wall



Local coordinate of Y-wall

Global coordinate

Figure 2-3-4 Relation between local coordinate and global coordinate

Transformation from the global node displacement to the element face displacement is,

$$\begin{Bmatrix} \theta'_{yAc} \\ \theta'_{yBc} \\ \theta'_{xA1} \\ \theta'_{xB1} \\ \theta'_{xA2} \\ \theta'_{xB2} \\ \delta'_{zc} \end{Bmatrix} = [n_w] [\Lambda_w] [D_w] [\varepsilon_w] [T_{ixw}] \begin{Bmatrix} u_1 \\ u_2 \\ \vdots \\ u_n \end{Bmatrix} = [T_{yw}] \begin{Bmatrix} u_1 \\ u_2 \\ \vdots \\ u_n \end{Bmatrix} \quad (2-3-24)$$

Constitutive equation

Finally, the constitutive equation of the wall is;

$$\begin{Bmatrix} P_1 \\ P_2 \\ \vdots \\ P_n \end{Bmatrix} = [K_{xw}] \begin{Bmatrix} u_1 \\ u_2 \\ \vdots \\ u_n \end{Bmatrix} \quad (2-3-25)$$

where,

$$[K_{xw}] = [T_{xw}]^T [k_w] [T_{xw}] \quad (2-3-26)$$

For Y-wall,

$$\begin{Bmatrix} P_1 \\ P_2 \\ \vdots \\ P_n \end{Bmatrix} = [K_{yw}] \begin{Bmatrix} u_1 \\ u_2 \\ \vdots \\ u_n \end{Bmatrix} \quad (2-3-27)$$

where,

$$[K_{yw}] = [T_{yw}]^T [k_w] [T_{yw}] \quad (2-3-28)$$

Transformation matrix for nonlinear spring displacement

The nonlinear spring displacement vector is obtained from Equations (2-3-7), (2-3-10)~(2-3-12),

2.4 Wall Panel

Element model for wall panel is introduced by removing the side columns from the wall model as shown in Figure 2-4-1.

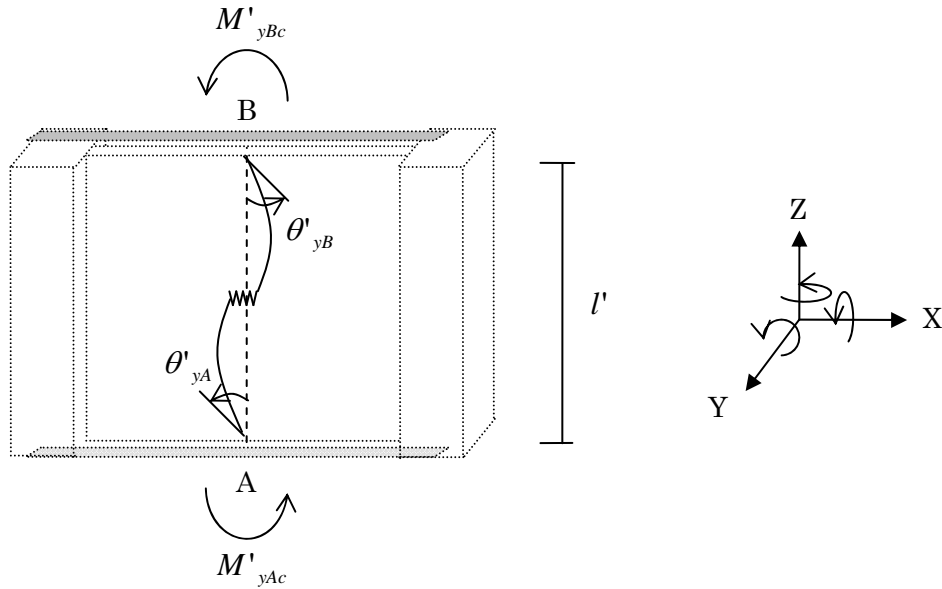

Figure 2-4-1 Element model for wall

Force-displacement relationship for elastic element

In the same way as the beam element, the relationship between the displacement vector and force vector of the elastic element is,

$$\begin{Bmatrix} \tau'_{yAc} \\ \tau'_{yBc} \end{Bmatrix} = \begin{bmatrix} \frac{l'}{3EI_c} & -\frac{l'}{6EI_c} \\ -\frac{l'}{6EI_c} & \frac{l'}{3EI_c} \end{bmatrix} \begin{Bmatrix} M'_{yAc} \\ M'_{yBc} \end{Bmatrix} \quad \text{in wall panel} \quad (2-4-1)$$

The axial displacement is,

$$\delta''_{zc} = \frac{l'}{EA} N'_{zc} \quad (2-4-2)$$

Force-displacement relationship for nonlinear bending springs

Nonlinear interaction $M_x - M_y - N_z$ is considered in the nonlinear bending springs,

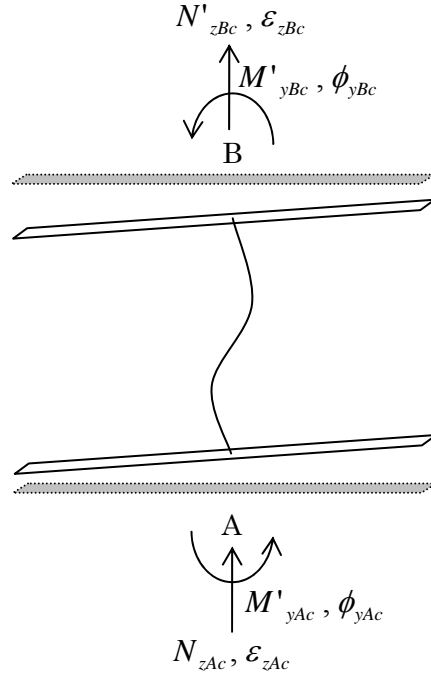

Figure 2-4-2 Nonlinear bending springs

$$\begin{Bmatrix} \phi_{yAc} \\ \varepsilon_{zAc} \end{Bmatrix} = [f_{pA}] \begin{Bmatrix} M'_{yAc} \\ N'_{zAc} \end{Bmatrix} \quad \text{at end A} \quad (2-4-3)$$

$$\begin{Bmatrix} \phi_{yBc} \\ \varepsilon_{zBc} \end{Bmatrix} = [f_{pB}] \begin{Bmatrix} M'_{yBc} \\ N'_{zBc} \end{Bmatrix} \quad \text{at end B} \quad (2-4-4)$$

where, $[f_{pA}]$ and $[f_{pB}]$ are the flexural stiffness matrices of the nonlinear bending springs. Therefore, the force-displacement relationship of nonlinear bending springs is,

$$\begin{Bmatrix} \phi_{yAc} \\ \varepsilon_{zAc} \\ \phi_{yBc} \\ \varepsilon_{zBc} \end{Bmatrix} = \begin{bmatrix} [f_{pA}] & 0 \\ 0 & [f_{pB}] \end{bmatrix} \begin{Bmatrix} M'_{yAc} \\ N'_{zAc} \\ M'_{yBc} \\ N'_{zBc} \end{Bmatrix} \quad (2-4-5)$$

Rearrange the order of the components of the displacement vector and change the node axial displacements into the relative axial displacement,

$$\begin{Bmatrix} \phi_{yAc} \\ \phi_{yBc} \\ \varepsilon_{zc} \end{Bmatrix} = \begin{bmatrix} 1 & & & \\ & 1 & & \\ & & -1 & \\ & & & 1 \end{bmatrix} \begin{Bmatrix} \phi_{yAc} \\ \varepsilon_{zAc} \\ \phi_{yBc} \\ \varepsilon_{zBc} \end{Bmatrix} = [n_p] \begin{Bmatrix} \phi_{yAc} \\ \varepsilon_{zAc} \\ \phi_{yBc} \\ \varepsilon_{zBc} \end{Bmatrix} \quad (2-4-6)$$

The force-displacement relationship in Equation (2-4-5) is then expressed as,

$$\begin{Bmatrix} \phi_{yAc} \\ \phi_{yBc} \\ \varepsilon_{zc} \end{Bmatrix} = [n_p] \begin{bmatrix} [f_{pA}] & 0 \\ 0 & [f_{pB}] \end{bmatrix} [n_p]^T \begin{Bmatrix} M'_{yAc} \\ M'_{yBc} \\ N'_{zc} \end{Bmatrix} = [f_p] \begin{Bmatrix} M'_{yAc} \\ M'_{yBc} \\ N'_{zc} \end{Bmatrix} \quad (2-4-7)$$

Force-displacement relationship for nonlinear shear springs

The rotational displacement vector from the shear deformation of the nonlinear shear spring is,

$$\begin{Bmatrix} \eta_{yAc} \\ \eta_{yBc} \end{Bmatrix} = \begin{bmatrix} \frac{1}{k_{sc} l'} & \frac{1}{k_{sc} l'} \\ \frac{1}{k_{sc} l'} & \frac{1}{k_{sc} l'} \end{bmatrix} \begin{Bmatrix} M'_{yAc} \\ M'_{yBc} \end{Bmatrix} \quad \text{in wall panel} \quad (2-4-8)$$

where, k_{sc} is the shear stiffness of the nonlinear shear springs.

The displacement vector of the column element is obtained as the sum of the displacement vectors of elastic element, nonlinear shear springs and nonlinear bending springs,

$$\begin{Bmatrix} \theta'_{yAc} \\ \theta'_{yBc} \\ \delta'_{zc} \end{Bmatrix} = \begin{Bmatrix} \tau'_{yAc} \\ \tau'_{yBc} \\ \delta'_{zc} \end{Bmatrix}_{\text{elastic element}} + \begin{Bmatrix} \phi_{yAc} \\ \phi_{yBc} \\ \varepsilon_{zc} \end{Bmatrix}_{\text{bending spring}} + \begin{Bmatrix} \eta_{yAc} \\ \eta_{yBc} \\ 0 \end{Bmatrix}_{\text{shear spring}} = [f_{WP}] \begin{Bmatrix} M'_{yAc} \\ M'_{yBc} \\ N'_{zc} \end{Bmatrix} \quad (2-4-9)$$

The flexural matrix $[f_{WP}]$ is;

$$[f_{WP}] = \begin{bmatrix} \frac{l'}{3EI_c} & -\frac{l'}{6EI_c} \\ & \frac{l'}{3EI_c} \\ \text{sym.} & & \frac{l'}{EA_c} \end{bmatrix}_{\text{elastic element}} + \begin{bmatrix} f_{p11} & f_{p12} & f_{p13} \\ & f_{p22} & f_{p32} \\ \text{sym.} & & f_{p33} \end{bmatrix}_{\text{bending spring}} + \begin{bmatrix} \frac{1}{k_{sc} l'} & \frac{1}{k_{sc} l'} \\ & \frac{1}{k_{sc} l'} \\ \text{sym.} & & 0 \end{bmatrix}_{\text{shear spring}} \quad (2-4-10)$$

By taking the inverse matrix of $[f_{WP}]$, the constitutive equation of the column element is obtained as,

$$\begin{Bmatrix} M'_{yAc} \\ M'_{yBc} \\ N'_{zc} \end{Bmatrix} = [f_{WP}]^{-1} \begin{Bmatrix} \theta'_{yAc} \\ \theta'_{yBc} \\ \delta'_{zc} \end{Bmatrix} = [k_{WP}] \begin{Bmatrix} \theta'_{yAc} \\ \theta'_{yBc} \\ \delta'_{zc} \end{Bmatrix} \quad (2-4-11)$$

Including rigid parts and node movement

Change relative axial displacement and torsion displacement into node displacement,

$$\begin{Bmatrix} \theta'_{yAc} \\ \theta'_{yBc} \\ \delta'_{zc} \end{Bmatrix} = \begin{bmatrix} 1 & & & \\ & 1 & & \\ & & -1 & 1 \end{bmatrix} \begin{Bmatrix} \theta'_{yAc} \\ \theta'_{yBc} \\ \delta'_{zAc} \\ \delta'_{zBc} \end{Bmatrix} = [n_{WP}] \begin{Bmatrix} \theta'_{yAc} \\ \theta'_{yBc} \\ \delta'_{zAc} \\ \delta'_{zBc} \end{Bmatrix} \quad (2-4-12)$$

Including rigid parts and node movement,

$$\begin{Bmatrix} \theta'_{yAc} \\ \theta'_{yBc} \\ \delta'_{zAc} \\ \delta'_{zBc} \end{Bmatrix} = \begin{bmatrix} -\frac{1}{l'} & \frac{1}{l'} & 1 + \lambda_A & \lambda_B \\ -\frac{1}{l'} & \frac{1}{l'} & \lambda_A & 1 + \lambda_B \\ & & & 1 \\ & & & 1 \end{bmatrix} \begin{Bmatrix} u_{xAc} \\ u_{xBc} \\ \theta_{yAc} \\ \theta_{yBc} \\ \delta_{zAc} \\ \delta_{zBc} \end{Bmatrix} = [\Lambda_{WP}] \begin{Bmatrix} u_{xAc} \\ u_{xBc} \\ \theta_{yAc} \\ \theta_{yBc} \\ \delta_{zAc} \\ \delta_{zBc} \end{Bmatrix} \quad (2-4-13)$$

From global node displacement to element node displacement

Transformation from the center displacements to the node displacements is,

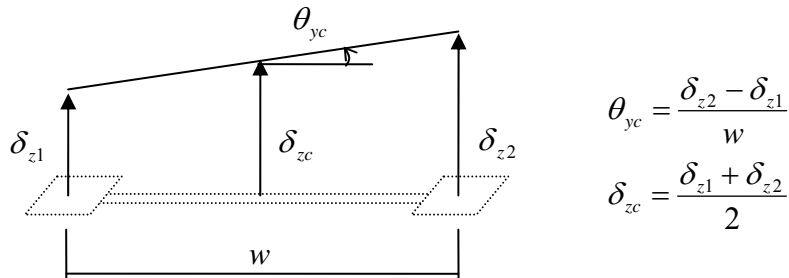

Figure 2-4-3 Relationship between center and node displacements

$$\begin{Bmatrix} u_{xAc} \\ u_{xBc} \\ \theta_{yAc} \\ \theta_{yBc} \\ \delta_{zAc} \\ \delta_{zBc} \end{Bmatrix} = \begin{bmatrix} 1 & & & & & \\ & -\frac{1}{w} & \frac{1}{w} & & & \\ & & & 1 & & \\ & & & & -\frac{1}{w} & \frac{1}{w} \\ & 0.5 & 0.5 & & & \\ & & & & 0.5 & 0.5 \end{bmatrix} \begin{Bmatrix} u_{xA1} \\ \delta_{zA1} \\ \delta_{zA2} \\ u_{xB1} \\ \delta_{zB1} \\ \delta_{zB2} \end{Bmatrix} = [D_{WP}] \begin{Bmatrix} u_{xA1} \\ \delta_{zA1} \\ \delta_{zA2} \\ u_{xB1} \\ \delta_{zB1} \\ \delta_{zB2} \end{Bmatrix} \quad (2-4-14)$$

Transformation from the global node displacements to the element node displacements is;

$$\begin{Bmatrix} u_{xA1} \\ \delta_{zA1} \\ \delta_{zA2} \\ u_{xB1} \\ \delta_{zB1} \\ \delta_{zB2} \end{Bmatrix} = [T_{ixWP}] \begin{Bmatrix} u_1 \\ u_2 \\ \vdots \\ u_n \end{Bmatrix} \quad (2-4-15)$$

The component of the transformation matrix, $[T_{ixWP}]$, is discussed in Chapter 4 (Freedom Vector).

From global node displacement to element face displacement

Transformation from the global node displacement to the element face displacement is,

$$\begin{Bmatrix} \theta'_{yAc} \\ \theta'_{yBc} \\ \delta'_{zc} \end{Bmatrix} = [n_{WP}] [\Lambda_{WP}] [D_{WP}] [T_{ixWP}] \begin{Bmatrix} u_1 \\ u_2 \\ \vdots \\ u_n \end{Bmatrix} = [T_{xWP}] \begin{Bmatrix} u_1 \\ u_2 \\ \vdots \\ u_n \end{Bmatrix} \quad (2-4-16)$$

In case of Y-direction wall

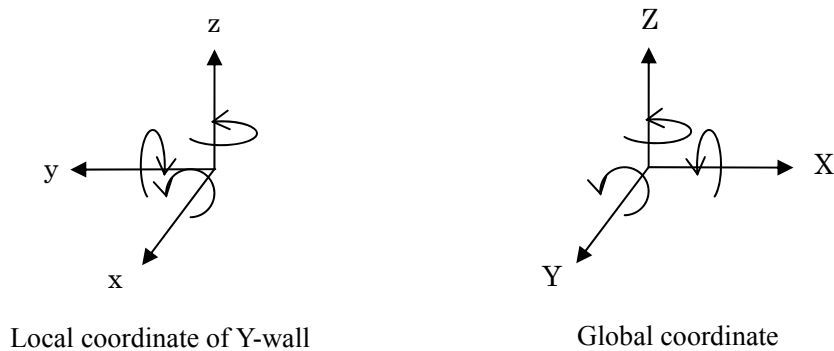

Figure 2-4-4 Relation between local coordinate and global coordinate

In case of Y-direction wall, the wall panel direction coincides to the Y-axis in the global coordinate, transformation of the sign of the vector components of the element coordinate is,

$$\begin{Bmatrix} x \\ y \\ z \end{Bmatrix}_{Y-Wall} = \begin{bmatrix} 0 & 1 & 0 \\ -1 & 0 & 0 \\ 0 & 0 & 1 \end{bmatrix} \begin{Bmatrix} X \\ Y \\ Z \end{Bmatrix}_{Global} \quad (2-4-17)$$

Therefore

$$\begin{Bmatrix} u_{xA1} \\ \delta_{zA1} \\ \delta_{zA2} \\ u_{xB1} \\ \delta_{zB1} \\ \delta_{zB2} \end{Bmatrix}_{Y\text{-Wall}} = \begin{bmatrix} 1 & & & & & \\ & 1 & & & & \\ & & 1 & & & \\ & & & 1 & & \\ & & & & 1 & \\ & & & & & 1 \end{bmatrix} \begin{Bmatrix} u_{yA1} \\ \delta_{zA1} \\ \delta_{zA2} \\ u_{yB1} \\ \delta_{zB1} \\ \delta_{zB2} \end{Bmatrix}_{Global} = [\varepsilon_{WP}] \begin{Bmatrix} u_{yA1} \\ \delta_{zA1} \\ \delta_{zA2} \\ u_{yB1} \\ \delta_{zB1} \\ \delta_{zB2} \end{Bmatrix}_{Global} \quad (2-4-18)$$

Transformation from the global node displacement to the element node displacement is;

$$\begin{Bmatrix} u_{yA1} \\ \delta_{zA1} \\ \delta_{zA2} \\ u_{yB1} \\ \delta_{zB1} \\ \delta_{zB2} \end{Bmatrix} = [T_{iyWP}] \begin{Bmatrix} u_1 \\ u_2 \\ \vdots \\ u_n \end{Bmatrix} \quad (2-4-19)$$

Transformation from the global node displacement to the element face displacement is,

$$\begin{Bmatrix} \theta'_{yAc} \\ \theta'_{yBc} \\ \delta'_{zc} \end{Bmatrix} = [n_{WP}] [\Lambda_{WP}] [D_{WP}] [\varepsilon_{WP}] [T_{ixWP}] \begin{Bmatrix} u_1 \\ u_2 \\ \vdots \\ u_n \end{Bmatrix} = [T_{yWP}] \begin{Bmatrix} u_1 \\ u_2 \\ \vdots \\ u_n \end{Bmatrix} \quad (2-4-20)$$

Constitutive equation

Finally, the constitutive equation of the wall is;

$$\begin{Bmatrix} P_1 \\ P_2 \\ \vdots \\ P_n \end{Bmatrix} = [K_{xWP}] \begin{Bmatrix} u_1 \\ u_2 \\ \vdots \\ u_n \end{Bmatrix} \quad (2-4-21)$$

where,

$$[K_{xWP}] = [T_{xWP}]^T [k_{WP}] [T_{xWP}] \quad (2-4-22)$$

For Y-wall,

$$\begin{Bmatrix} P_1 \\ P_2 \\ \vdots \\ P_n \end{Bmatrix} = [K_{yWP}] \begin{Bmatrix} u_1 \\ u_2 \\ \vdots \\ u_n \end{Bmatrix} \quad (2-4-23)$$

where,

$$[K_{yWP}] = [T_{yWP}]^T [k_{WP}] [T_{yWP}] \quad (2-4-24)$$

Transformation matrix for nonlinear spring displacement

The nonlinear spring displacement vector is,

$$\begin{Bmatrix} \phi_{yAc} \\ \varepsilon_{zAc} \\ \phi_{yBc} \\ \varepsilon_{zBc} \\ \eta_{yc} \end{Bmatrix} = \begin{bmatrix} [f_{pA}] & & & \\ & [f_{pA}] & & \\ & & \frac{1}{k_{sc} l'} & 0 \\ & & 0 & \frac{1}{k_{sc} l'} \end{bmatrix} \begin{Bmatrix} M'_{yAc} \\ N'_{zAc} \\ M'_{yBc} \\ N'_{zBc} \end{Bmatrix} = [f_{pWP}] \begin{Bmatrix} M'_{yAc} \\ N'_{zAc} \\ M'_{yBc} \\ N'_{zBc} \end{Bmatrix} \quad (2-4-25)$$

Furthermore, in the same way as Equation (2-4-6),

$$\begin{Bmatrix} M'_{yAc} \\ N'_{zAc} \\ M'_{yBc} \\ N'_{zBc} \end{Bmatrix} = [n_p]^T \begin{Bmatrix} M'_{yAc} \\ M'_{yBc} \\ N'_{zc} \end{Bmatrix} \quad (2-4-26)$$

Therefore, the nonlinear spring displacement vector is obtained from the element face displacement as,

$$\begin{Bmatrix} \phi_{yAc} \\ \varepsilon_{zAc} \\ \phi_{yBc} \\ \varepsilon_{zBc} \\ \eta_{yc} \end{Bmatrix} = [f_{pWP}] [n_p]^T \begin{Bmatrix} M'_{yAc} \\ M'_{yBc} \\ N'_{zc} \end{Bmatrix} = [f_{pWP}] [n_p]^T [k_{WP}] \begin{Bmatrix} \theta'_{yAc} \\ \theta'_{yBc} \\ \delta'_{zc} \end{Bmatrix} = [T_{pWP}] \begin{Bmatrix} \theta'_{yAc} \\ \theta'_{yBc} \\ \delta'_{zc} \end{Bmatrix} \quad (2-4-27)$$

2.5 External Spring

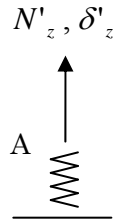

Figure 2-5-1 Element model for external spring

Force-displacement relationship for the element

The relationship between the displacement vector and force vector of the elastic element in Figure 2-5-1 is expressed as follows:

$$\{N'_x\} = [k_E] \{\delta'_z\} \quad (2-5-1)$$

From global node displacement to element node displacement

Transformation from the global node displacement to the element node displacement is,

$$\{\delta'_z\} = [T_E] \begin{Bmatrix} u_1 \\ u_2 \\ \vdots \\ u_n \end{Bmatrix} \quad (2-5-2)$$

The component of the transformation matrix, $[T_E]$, is discussed in Chapter 4 (Freedom Vector).

Constitutive equation

The constitutive equation of the external spring is;

$$\begin{Bmatrix} P_1 \\ P_2 \\ \vdots \\ P_n \end{Bmatrix} = [K_E] \begin{Bmatrix} u_1 \\ u_2 \\ \vdots \\ u_n \end{Bmatrix} \quad (2-5-3)$$

where,

$$[K_E] = [T_E]^T [k_E] [T_E] \quad (2-5-4)$$

2.6 Base Isolation

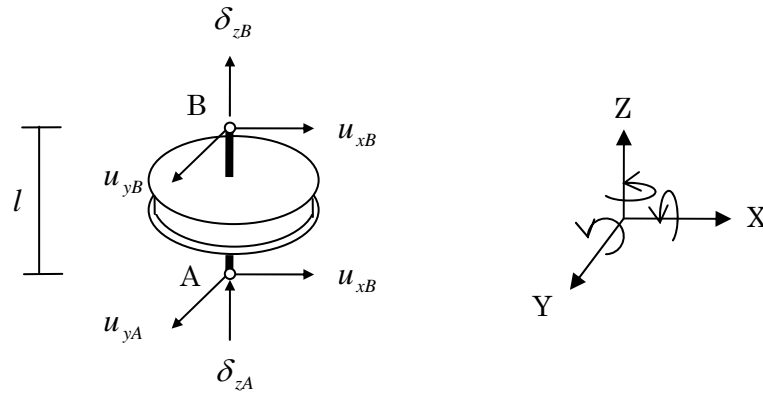

Figure 2-6-1 Element model for base isolation

Force-displacement relationship for the element

The relationship between the displacement vector and force vector of the element is expressed as follows:

$$\begin{Bmatrix} Q'_x \\ Q'_y \end{Bmatrix} = [k_{pBI}] \begin{Bmatrix} \delta'_x \\ \delta'_y \end{Bmatrix} \quad (2-6-1)$$

Including the axial stiffness,

$$\begin{Bmatrix} Q'_x \\ Q'_y \\ \delta'_z \end{Bmatrix} = \begin{bmatrix} [k_{pBI}] & 0 \\ 0 & \frac{EA}{l'} \end{bmatrix} \begin{Bmatrix} \delta'_x \\ \delta'_y \\ \delta'_z \end{Bmatrix} = [k_{BI}] \begin{Bmatrix} \delta'_x \\ \delta'_y \\ \delta'_z \end{Bmatrix} \quad (2-6-2)$$

From node displacements, relative displacements are;

$$\begin{aligned} \delta'_x &= u_{xB} - u_{xA} \\ \delta'_y &= u_{yB} - u_{yA} \\ \delta'_z &= \delta_{zB} - \delta_{zA} \end{aligned} \quad (2-6-3)$$

Therefore

$$\begin{Bmatrix} \delta'_x \\ \delta'_y \\ \delta'_z \end{Bmatrix} = \begin{bmatrix} -1 & 1 & & & & \\ & -1 & 1 & & & \\ & & & -1 & 1 & \\ & & & & & & -1 & 1 \end{bmatrix} \begin{Bmatrix} u_{xA} \\ u_{xB} \\ u_{yA} \\ u_{yB} \\ \delta_{zA} \\ \delta_{zB} \end{Bmatrix} = [n_{BI}] \begin{Bmatrix} u_{xA} \\ u_{xB} \\ u_{yA} \\ u_{yB} \\ \delta_{zA} \\ \delta_{zB} \end{Bmatrix} \quad (2-6-4)$$

From global node displacement to element node displacement

Transformation from the global node displacement to the element node displacement is,

$$\begin{Bmatrix} u_{xA} \\ u_{xB} \\ u_{yA} \\ u_{yB} \\ \delta_{zA} \\ \delta_{zB} \end{Bmatrix} = [T_{iBl}] \begin{Bmatrix} u_1 \\ u_2 \\ \vdots \\ u_n \end{Bmatrix} \quad (2-6-5)$$

The component of the transformation matrix, $[T_{iBl}]$, is discussed in Chapter 4 (Freedom Vector).

From global node displacement to element face displacement

Transformation from the global node displacement to the element face displacement is,

$$\begin{Bmatrix} \delta'_x \\ \delta'_y \\ \delta'_z \end{Bmatrix} = [n_{Bl}] [T_{iBl}] \begin{Bmatrix} u_1 \\ u_2 \\ \vdots \\ u_n \end{Bmatrix} = [T_{Bl}] \begin{Bmatrix} u_1 \\ u_2 \\ \vdots \\ u_n \end{Bmatrix} \quad (2-6-6)$$

Constitutive equation

The constitutive equation of the Base isolation is;

$$\begin{Bmatrix} P_1 \\ P_2 \\ \vdots \\ P_n \end{Bmatrix} = [K_{Bl}] \begin{Bmatrix} u_1 \\ u_2 \\ \vdots \\ u_n \end{Bmatrix} \quad (2-6-7)$$

where,

$$[K_{Bl}] = [T_{Bl}]^T [k_{Bl}] [T_{Bl}] \quad (2-6-8)$$

2.7 Masonry Wall

Element model for Masonry wall is defined as a line element with a nonlinear shear spring and a vertical spring in the middle of the wall panel as shown in Figure 2-6-1.

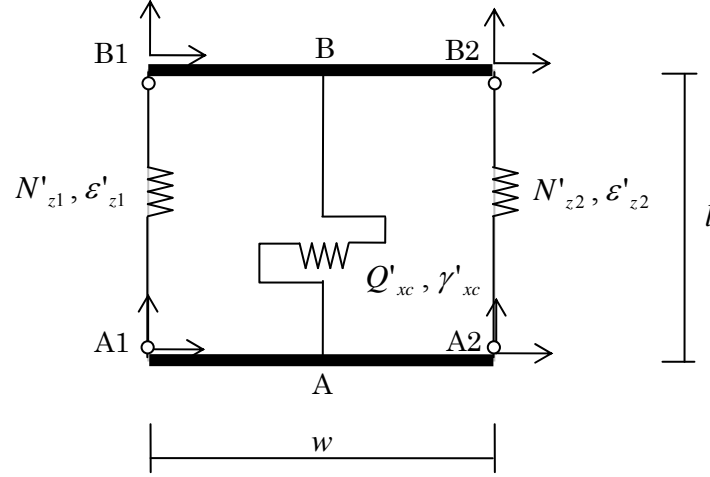

Figure 2-7-1 Element model for masonry wall

Force-displacement relationship

The relationship between the shear deformation and shear force of the nonlinear shear spring is,

$$Q'_{xc} = k_{sx} \gamma'_{xc} \quad (2-7-1)$$

For axial spring,

$$N'_{z1} = k_z \epsilon'_{z1}, \quad N'_{z2} = k_z \epsilon'_{z2} \quad (2-7-2)$$

In a matrix form,

$$\begin{Bmatrix} Q'_{xc} \\ N'_{z1} \\ N'_{z2} \end{Bmatrix} = \begin{bmatrix} k_{sx} & 0 & 0 \\ 0 & k_z & 0 \\ 0 & 0 & k_z \end{bmatrix} \begin{Bmatrix} \gamma'_{xc} \\ \epsilon'_{z1} \\ \epsilon'_{z2} \end{Bmatrix} = [k_N] \begin{Bmatrix} \gamma'_{xc} \\ \epsilon'_{z1} \\ \epsilon'_{z2} \end{Bmatrix} \quad (2-7-3)$$

Including node movement

The shear angle of the frame with four nodes, A1, A2, B1, B2, is defined as,

$$\tau = \frac{\partial \delta_z}{\partial x} + \frac{\partial u_x}{\partial z} \quad (2-7-4)$$

where,

$$\frac{\partial \delta_z}{\partial x} \approx \frac{1}{2} \left(\frac{\delta_{zA2} - \delta_{zA1}}{w} + \frac{\delta_{zB2} - \delta_{zB1}}{w} \right) \quad (2-7-5)$$

$$\frac{\partial u_z}{\partial z} \approx \frac{1}{2} \left(\frac{u_{xB1} - u_{xA1}}{l} + \frac{u_{xB2} - u_{xA2}}{l} \right) \quad (2-7-6)$$

The shear deformation, γ'_{xc} , is then,

$$\gamma'_{xc} = \tau l = \frac{l}{2w} (\delta_{zA2} - \delta_{zA1} + \delta_{zB2} - \delta_{zB1}) + \frac{1}{2} (u_{xB1} - u_{xA1} + u_{xB2} - u_{xA2}) \quad (2-7-7)$$

The axial deformation, $\varepsilon'_{z1}, \varepsilon'_{z2}$, is,

$$\varepsilon'_{z1} = \delta_{zB1} - \delta_{zA1}, \quad \varepsilon'_{z2} = \delta_{zB2} - \delta_{zA2} \quad (2-7-8)$$

In a matrix form,

$$\begin{Bmatrix} \gamma'_{xc} \\ \varepsilon'_{z1} \\ \varepsilon'_{z2} \end{Bmatrix} = \begin{bmatrix} -0.5 & -0.5 \frac{l}{w} & -0.5 & 0.5 \frac{l}{w} & 0.5 & -0.5 \frac{l}{w} & 0.5 & 0.5 \frac{l}{w} \\ 0 & -1 & 0 & 0 & 0 & 1 & 0 & 0 \\ 0 & 0 & 0 & -1 & 0 & 0 & 0 & 1 \end{bmatrix} \begin{Bmatrix} u_{xA1} \\ \delta_{zA1} \\ u_{xA2} \\ \delta_{zA2} \\ u_{xB1} \\ \delta_{zB1} \\ u_{xB2} \\ \delta_{zB2} \end{Bmatrix} = [D_N] \begin{Bmatrix} u_{xA1} \\ \delta_{zA1} \\ u_{xA2} \\ \delta_{zA2} \\ u_{xB1} \\ \delta_{zB1} \\ u_{xB2} \\ \delta_{zB2} \end{Bmatrix} \quad (2-7-9)$$

From global node displacement to element node displacement

Transformation from the global node displacement to the element node displacement is;

$$\begin{Bmatrix} u_{xA1} \\ \delta_{zA1} \\ u_{xA2} \\ \delta_{zA2} \\ u_{xB1} \\ \delta_{zB1} \\ u_{xB2} \\ \delta_{zB2} \end{Bmatrix} = [T_{ixN}] \begin{Bmatrix} u_1 \\ u_2 \\ \vdots \\ u_n \end{Bmatrix} \quad (2-7-10)$$

The component of the transformation matrix, $[T_{ixN}]$, is discussed in Chapter 4 (Freedom Vector).

From global node displacement to element face displacement

Transformation from the global node displacement to the element face displacement is,

$$\begin{Bmatrix} \gamma'_{xc} \\ \varepsilon'_{z1} \\ \varepsilon'_{z2} \end{Bmatrix} = [D_N][T_{ixN}] \begin{Bmatrix} u_1 \\ u_2 \\ \vdots \\ u_n \end{Bmatrix} = [T_{xN}] \begin{Bmatrix} u_1 \\ u_2 \\ \vdots \\ u_n \end{Bmatrix} \quad (2-7-11)$$

In case of Y-direction wall

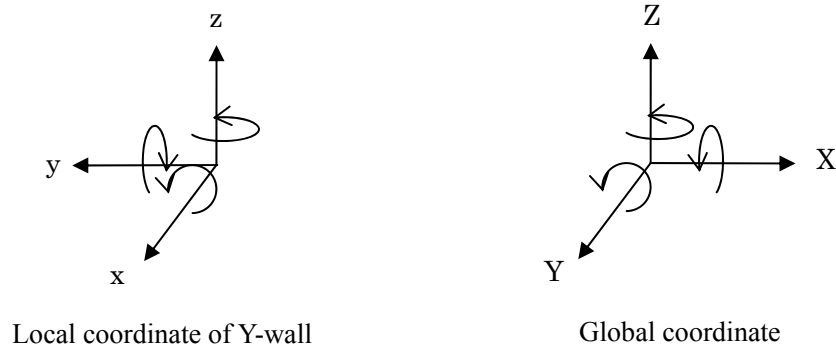

Figure 2-6-2 Relation between local coordinate and global coordinate

In case of Y-direction wall, the wall panel direction coincides to the Y-axis in the global coordinate, transformation of the sign of the vector components of the element coordinate is,

$$\begin{Bmatrix} x \\ y \\ z \end{Bmatrix}_{Y\text{-Beam}} = \begin{bmatrix} 0 & 1 & 0 \\ -1 & 0 & 0 \\ 0 & 0 & 1 \end{bmatrix} \begin{Bmatrix} X \\ Y \\ Z \end{Bmatrix}_{Global} \quad (2-7-12)$$

Therefore

$$\begin{Bmatrix} u_{xA1} \\ \delta_{zA1} \\ u_{xA2} \\ \delta_{zA2} \\ u_{xB1} \\ \delta_{zB1} \\ u_{xB2} \\ \delta_{zB2} \end{Bmatrix}_{Y\text{-Wall}} = \begin{bmatrix} 1 & & & & & & & \\ & 1 & & & & & & \\ & & 1 & & & & & \\ & & & 1 & & & & \\ & & & & 1 & & & \\ & & & & & 1 & & \\ & & & & & & 1 & \\ & & & & & & & 1 \end{bmatrix} \begin{Bmatrix} u_{yA1} \\ \delta_{zA1} \\ u_{yA2} \\ \delta_{zA2} \\ u_{yB1} \\ \delta_{zB1} \\ u_{yB2} \\ \delta_{zB2} \end{Bmatrix}_{Global} = \begin{Bmatrix} u_{yA1} \\ \delta_{zA1} \\ u_{yA2} \\ \delta_{zA2} \\ u_{yB1} \\ \delta_{zB1} \\ u_{yB2} \\ \delta_{zB2} \end{Bmatrix}_{Global} \quad (2-7-13)$$

Transformation from the global node displacement to the element node displacement is;

$$\begin{Bmatrix} u_{yA1} \\ \delta_{zA1} \\ u_{yA2} \\ \delta_{zA2} \\ u_{yB1} \\ \delta_{zB1} \\ u_{yB2} \\ \delta_{zB2} \end{Bmatrix} = [T_{iyN}] \begin{Bmatrix} u_1 \\ u_2 \\ \vdots \\ u_n \end{Bmatrix} \quad (2-7-14)$$

Transformation from the global node displacement to the element face displacement is,

$$\begin{Bmatrix} \gamma'_{xc} \\ \varepsilon'_{z1} \\ \varepsilon'_{z2} \end{Bmatrix} = [D_N] [T_{iyN}] \begin{Bmatrix} u_1 \\ u_2 \\ \vdots \\ u_n \end{Bmatrix} = [T_{yN}] \begin{Bmatrix} u_1 \\ u_2 \\ \vdots \\ u_n \end{Bmatrix} \quad (2-7-15)$$

Constitutive equation

Finally, the constitutive equation of the wall is;

$$\begin{Bmatrix} P_1 \\ P_2 \\ \vdots \\ P_n \end{Bmatrix} = [K_{xN}] \begin{Bmatrix} u_1 \\ u_2 \\ \vdots \\ u_n \end{Bmatrix} \quad (2-7-16)$$

where,

$$[K_{xN}] = [T_{xN}]^T [k_N] [T_{xN}] \quad (2-7-17)$$

For Y-wall,

$$\begin{Bmatrix} P_1 \\ P_2 \\ \vdots \\ P_n \end{Bmatrix} = [K_{yN}] \begin{Bmatrix} u_1 \\ u_2 \\ \vdots \\ u_n \end{Bmatrix} \quad (2-7-18)$$

where,

$$[K_{yN}] = [T_{yN}]^T [k_N] [T_{yN}] \quad (2-7-19)$$

2.8 Passive Damper

Element model for passive damper is defined as a line element with a nonlinear shear spring as shown in Figure 2-8-1.

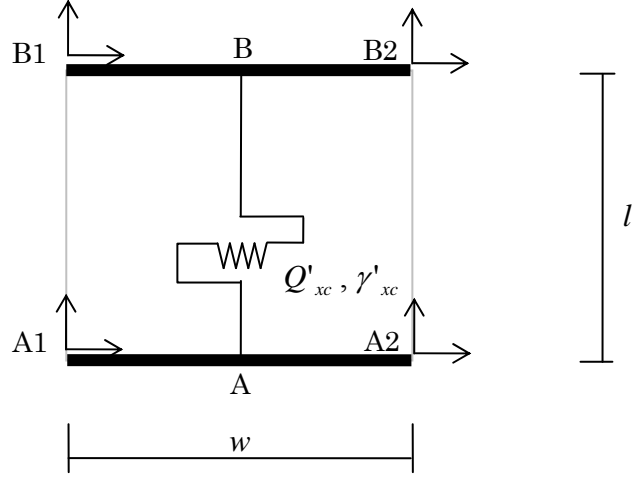

Figure 2-8-1 Element model for passive damper

Force-displacement relationship

The relationship between the shear deformation and shear force of the nonlinear shear spring is,

$$Q'_{xc} = k_{sx} \gamma'_{xc} \quad (2-8-1)$$

Including node movement

The shear angle of the frame with four nodes, A1, A2, B1, B2, is defined as,

$$\tau = \frac{\partial \delta_z}{\partial x} + \frac{\partial u_x}{\partial z} \quad (2-8-2)$$

where,

$$\frac{\partial \delta_z}{\partial x} \approx \frac{1}{2} \left(\frac{\delta_{zA2} - \delta_{zA1}}{w} + \frac{\delta_{zB2} - \delta_{zB1}}{w} \right) \quad (2-8-3)$$

$$\frac{\partial u_x}{\partial z} \approx \frac{1}{2} \left(\frac{u_{xB1} - u_{xA1}}{l} + \frac{u_{xB2} - u_{xA2}}{l} \right) \quad (2-8-4)$$

The shear deformation, γ'_{xc} , is then,

$$\gamma'_{xc} = \tau l = \frac{l}{2w} (\delta_{zA2} - \delta_{zA1} + \delta_{zB2} - \delta_{zB1}) + \frac{1}{2} (u_{xB1} - u_{xA1} + u_{xB2} - u_{xA2}) \quad (2-8-5)$$

The axial deformation, $\varepsilon'_{z1}, \varepsilon'_{z2}$, is,

$$\varepsilon'_{z1} = \delta_{zB1} - \delta_{zA1}, \quad \varepsilon'_{z2} = \delta_{zB2} - \delta_{zA2} \quad (2-8-6)$$

In a matrix form,

$$\begin{Bmatrix} \gamma'_{xc} \\ \varepsilon'_{z1} \\ \varepsilon'_{z2} \end{Bmatrix} = \begin{bmatrix} -0.5 & -0.5 \frac{l}{w} & -0.5 & 0.5 \frac{l}{w} & 0.5 & -0.5 \frac{l}{w} & 0.5 & 0.5 \frac{l}{w} \\ 0 & -1 & 0 & 0 & 0 & 1 & 0 & 0 \\ 0 & 0 & 0 & -1 & 0 & 0 & 0 & 1 \end{bmatrix} \begin{Bmatrix} u_{xA1} \\ \delta_{zA1} \\ u_{xA2} \\ \delta_{zA2} \\ u_{xB1} \\ \delta_{zB1} \\ u_{xB2} \\ \delta_{zB2} \end{Bmatrix} = [D_D] \begin{Bmatrix} u_{xA1} \\ \delta_{zA1} \\ u_{xA2} \\ \delta_{zA2} \\ u_{xB1} \\ \delta_{zB1} \\ u_{xB2} \\ \delta_{zB2} \end{Bmatrix} \quad (2-8-7)$$

From global node displacement to element node displacement

Transformation from the global node displacement to the element node displacement is;

$$\begin{Bmatrix} u_{xA1} \\ \delta_{zA1} \\ u_{xA2} \\ \delta_{zA2} \\ u_{xB1} \\ \delta_{zB1} \\ u_{xB2} \\ \delta_{zB2} \end{Bmatrix} = [T_{ixD}] \begin{Bmatrix} u_1 \\ u_2 \\ \vdots \\ u_n \end{Bmatrix} \quad (2-8-8)$$

The component of the transformation matrix, $[T_{ixD}]$, is discussed in Chapter 4 (Freedom Vector).

From global node displacement to element face displacement

Transformation from the global node displacement to the element face displacement is,

$$\begin{Bmatrix} \gamma'_{xc} \\ \varepsilon'_{z1} \\ \varepsilon'_{z2} \end{Bmatrix} = [D_D][T_{ixD}] \begin{Bmatrix} u_1 \\ u_2 \\ \vdots \\ u_n \end{Bmatrix} = [T_{xD}] \begin{Bmatrix} u_1 \\ u_2 \\ \vdots \\ u_n \end{Bmatrix} \quad (2-8-9)$$

In case of Y-direction damper

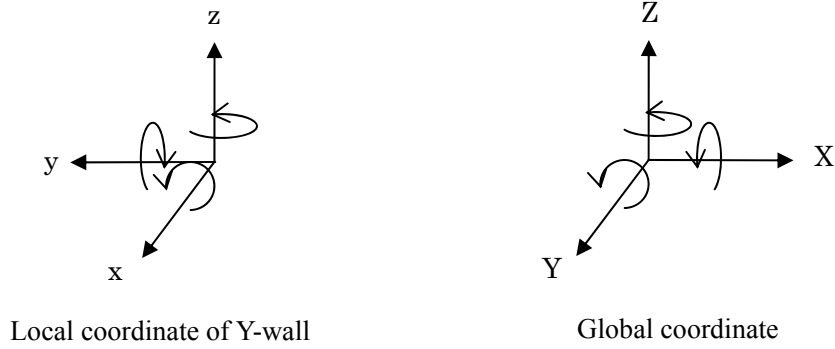

Figure 2-7-2 Relation between local coordinate and global coordinate

In case of Y-direction damper, the damper direction coincides to the Y-axis in the global coordinate, transformation of the sign of the vector components of the element coordinate is,

$$\begin{Bmatrix} x \\ y \\ z \end{Bmatrix}_{Y\text{-Beam}} = \begin{bmatrix} 0 & 1 & 0 \\ -1 & 0 & 0 \\ 0 & 0 & 1 \end{bmatrix} \begin{Bmatrix} X \\ Y \\ Z \end{Bmatrix}_{Global} \quad (2-8-10)$$

Therefore

$$\begin{Bmatrix} u_{xA1} \\ \delta_{zA1} \\ u_{xA2} \\ \delta_{zA2} \\ u_{xB1} \\ \delta_{zB1} \\ u_{xB2} \\ \delta_{zB2} \end{Bmatrix}_{Y\text{-Wall}} = \begin{bmatrix} 1 & & & & & & & \\ & 1 & & & & & & \\ & & 1 & & & & & \\ & & & 1 & & & & \\ & & & & 1 & & & \\ & & & & & 1 & & \\ & & & & & & 1 & \\ & & & & & & & 1 \end{bmatrix} \begin{Bmatrix} u_{yA1} \\ \delta_{zA1} \\ u_{yA2} \\ \delta_{zA2} \\ u_{yB1} \\ \delta_{zB1} \\ u_{yB2} \\ \delta_{zB2} \end{Bmatrix}_{Global} = \begin{Bmatrix} u_{yA1} \\ \delta_{zA1} \\ u_{yA2} \\ \delta_{zA2} \\ u_{yB1} \\ \delta_{zB1} \\ u_{yB2} \\ \delta_{zB2} \end{Bmatrix}_{Global} \quad (2-8-11)$$

Transformation from the global node displacement to the element node displacement is;

$$\begin{Bmatrix} u_{yA1} \\ \delta_{zA1} \\ u_{yA2} \\ \delta_{zA2} \\ u_{yB1} \\ \delta_{zB1} \\ u_{yB2} \\ \delta_{zB2} \end{Bmatrix} = [T_{yD}] \begin{Bmatrix} u_1 \\ u_2 \\ \vdots \\ u_n \end{Bmatrix} \quad (2-8-12)$$

Transformation from the global node displacement to the element face displacement is,

$$\begin{Bmatrix} \gamma'_{xc} \\ \varepsilon'_{z1} \\ \varepsilon'_{z2} \end{Bmatrix} = [D_D] [T_{iyD}] \begin{Bmatrix} u_1 \\ u_2 \\ \vdots \\ u_n \end{Bmatrix} = [T_{yD}] \begin{Bmatrix} u_1 \\ u_2 \\ \vdots \\ u_n \end{Bmatrix} \quad (2-8-13)$$

Constitutive equation

Finally, the constitutive equation of the damper is;

$$\begin{Bmatrix} P_1 \\ P_2 \\ \vdots \\ P_n \end{Bmatrix} = [K_{xD}] \begin{Bmatrix} u_1 \\ u_2 \\ \vdots \\ u_n \end{Bmatrix} \quad (2-8-14)$$

where,

$$[K_{xD}] = [T_{xD}]^T [k_D] [T_{xD}] \quad (2-8-15)$$

For Y-damper,

$$\begin{Bmatrix} P_1 \\ P_2 \\ \vdots \\ P_n \end{Bmatrix} = [K_{yD}] \begin{Bmatrix} u_1 \\ u_2 \\ \vdots \\ u_n \end{Bmatrix} \quad (2-8-16)$$

where,

$$[K_{yD}] = [T_{yD}]^T [k_D] [T_{yD}] \quad (2-8-17)$$

Appendix) Calculation of shear component

For “Masonry Wall” and “Passive Damper”, the shear deformation is defined as follows:

1) Shear deformation in one direction

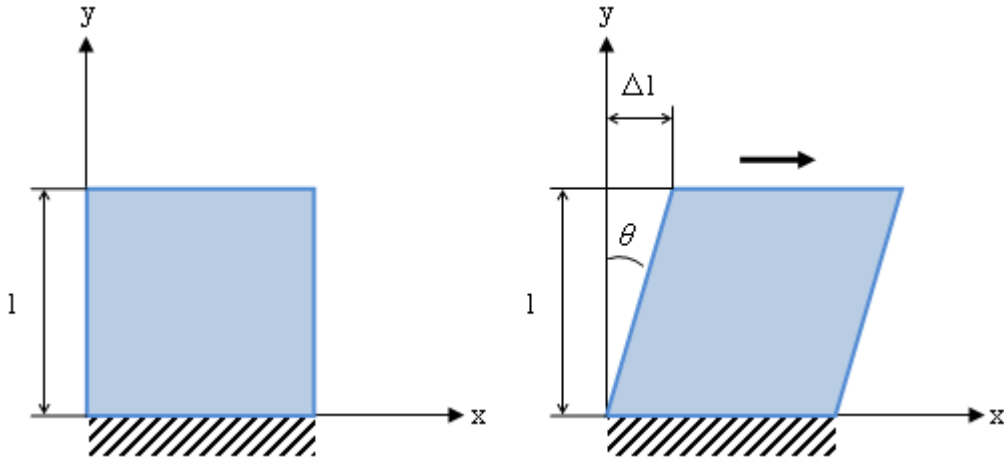

Shear strain is $\tau = \Delta l / l \approx \theta$

2) Shear deformation in two directions

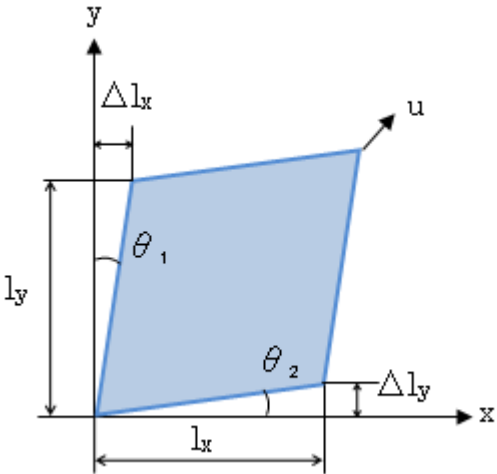

Shear strain is $\tau = \theta_1 + \theta_2 = \Delta l_x / l_y + \Delta l_y / l_x$

If we discuss small element $\tau = \frac{\partial u_x}{\partial y} + \frac{\partial u_y}{\partial x} \rightarrow$ Eq. (2-7-4) and Eq. (2-8-2)

This definition is necessary to remove rotational component. To explain this, suppose there is only rotational (or bending) deformation,

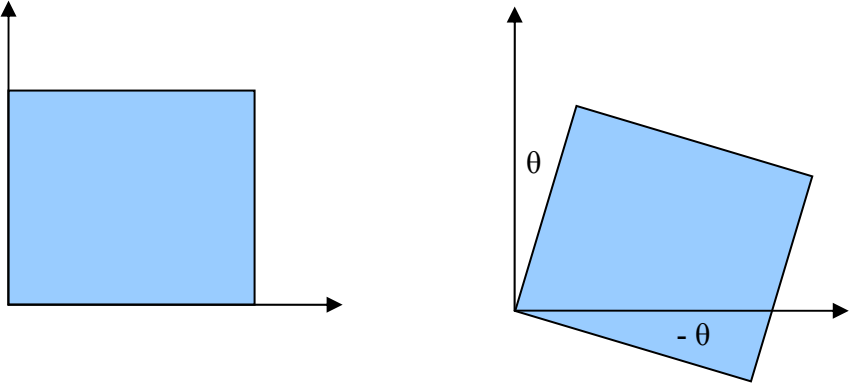

From the above definition, shear angle will be

$$\tau = \theta + (-\theta) = 0$$

For example, in the upper story of the building under horizontal deformation, the bending component is dominant and the shear component is small. Therefore, the brace damper doesn't work in the upper story.

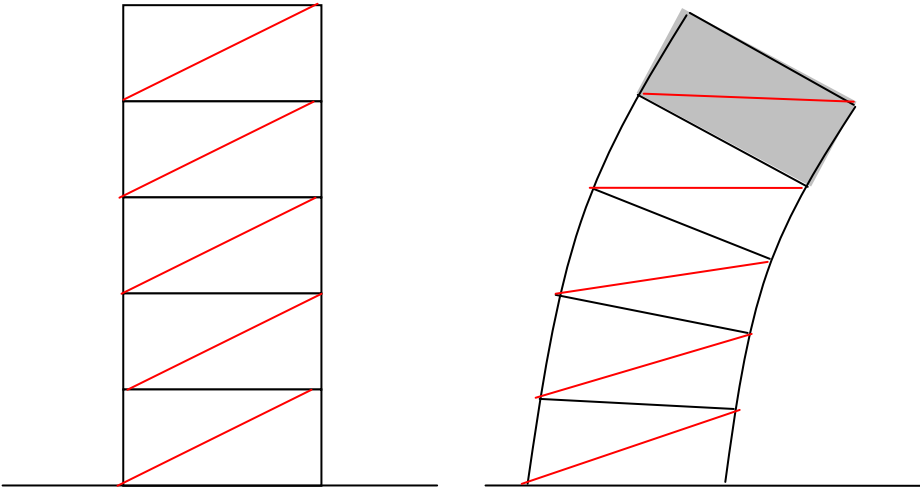

3) In case of damper element

We define the shear angle in one direction as follows:

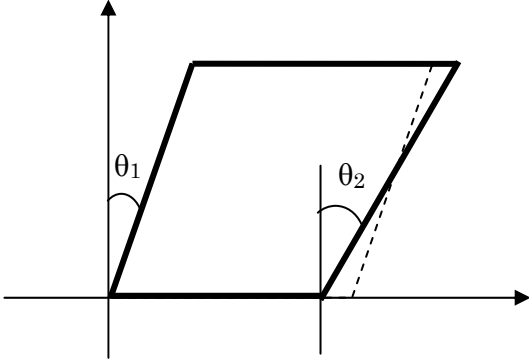

We adopt the average angle,

$$\theta = 1/2 (\theta_1 + \theta_2) \quad \rightarrow \quad \text{Eq. (2-7-5) and Eq. (2-8-3)}$$

In the same way, the shear angle in another direction is

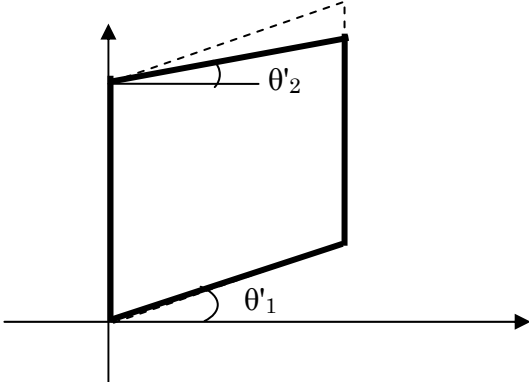

$$\theta' = 1/2 (\theta'_1 + \theta'_2) \quad \rightarrow \quad \text{Eq. (2-7-6) and Eq. (2-8-4)}$$

2.9 Floor Element

In the default setting, STERA 3D adopts “rigid floor”. However, elastic deformation of a floor diaphragm in-plane can be considered by the option menu selecting “flexible floor”. The stiffness matrix of the floor element is constructed using a two dimensional isoparametric element.

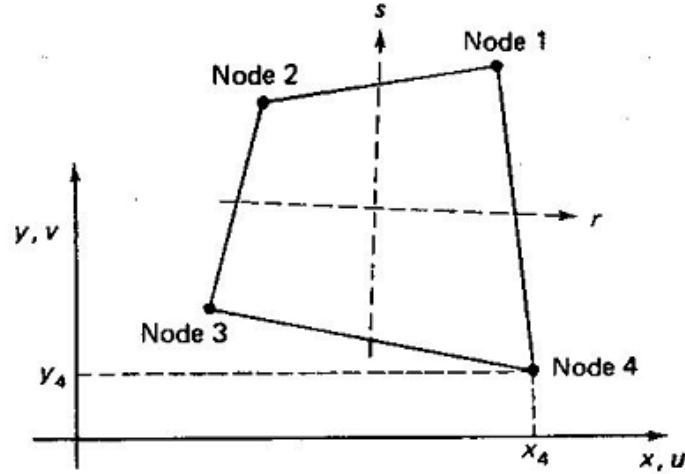

Figure 2-9-1 4-nodes isoparametric element

The stiffness matrix with 4-nodes isoparametric is expressed as,

$$\begin{Bmatrix} P_1 \\ Q_1 \\ P_2 \\ Q_2 \\ P_3 \\ Q_3 \\ P_4 \\ Q_4 \end{Bmatrix} = [K_F] \begin{Bmatrix} u_1 \\ v_1 \\ u_2 \\ v_2 \\ u_3 \\ v_3 \\ u_4 \\ v_4 \end{Bmatrix}$$

$$\mathbf{F} = \mathbf{K} \mathbf{u} \quad (2-9-1)$$

The coordinate transfer function $\{x, y\}$ is expressed using the interpolation functions as follows:

$$\begin{aligned} x(r, s) &= \sum_{i=1}^4 h_i(r, s)x_i = \frac{1}{4}(1+r)(1+s)x_1 + \frac{1}{4}(1-r)(1+s)x_2 + \frac{1}{4}(1-r)(1-s)x_3 + \frac{1}{4}(1+r)(1-s)x_4 \\ y(r, s) &= \sum_{i=1}^4 h_i(r, s)y_i = \frac{1}{4}(1+r)(1+s)y_1 + \frac{1}{4}(1-r)(1+s)y_2 + \frac{1}{4}(1-r)(1-s)y_3 + \frac{1}{4}(1+r)(1-s)y_4 \end{aligned} \quad (2-9-2)$$

The deformation function $\{u, v\}$ is also expressed using the same interpolation functions.

$$u(r, s) = \sum_{i=1}^4 h_i(r, s)u_i = \frac{1}{4}(1+r)(1+s)u_1 + \frac{1}{4}(1-r)(1+s)u_2 + \frac{1}{4}(1-r)(1-s)u_3 + \frac{1}{4}(1+r)(1-s)u_4$$

$$v(r, s) = \sum_{i=1}^4 h_i(r, s)v_i = \frac{1}{4}(1+r)(1+s)v_1 + \frac{1}{4}(1-r)(1+s)v_2 + \frac{1}{4}(1-r)(1-s)v_3 + \frac{1}{4}(1+r)(1-s)v_4$$

(2-9-3)

Stiffness matrix can be obtained from the “*Principle of Virtual Work Method*,” which is expressed in the following form:

$$\int_V \bar{\epsilon}^T \sigma \, dv = \bar{u}^T F \quad (2-9-4)$$

where, $\bar{\epsilon}$ is a virtual strain vector, σ is a stress vector, \bar{u} is a virtual displacement vector and F is a load vector, respectively.

In case of the plane problem, the strain ϵ vector is defined as,

$$\begin{pmatrix} \epsilon_x \\ \epsilon_y \\ \gamma_{xy} \end{pmatrix} = \begin{pmatrix} \frac{\partial u}{\partial x} \\ \frac{\partial v}{\partial y} \\ \frac{\partial u}{\partial y} + \frac{\partial v}{\partial x} \end{pmatrix} \quad (2-9-5)$$

Substituting equation (2-9-3) into equation (2-9-5), the strain vector is calculated from the nodal displacement vector as,

$$\begin{pmatrix} \epsilon_x \\ \epsilon_y \\ \gamma_{xy} \end{pmatrix} = \begin{pmatrix} \frac{\partial u}{\partial x} \\ \frac{\partial v}{\partial y} \\ \frac{\partial u}{\partial y} + \frac{\partial v}{\partial x} \end{pmatrix} = \begin{pmatrix} \sum_{i=1}^4 \frac{\partial h_i}{\partial x} u_i \\ \sum_{i=1}^4 \frac{\partial h_i}{\partial y} v_i \\ \sum_{i=1}^4 \frac{\partial h_i}{\partial y} u_i + \sum_{i=1}^4 \frac{\partial h_i}{\partial x} v_i \end{pmatrix}$$

$$= \begin{pmatrix} \frac{\partial h_1}{\partial x} & 0 & \frac{\partial h_2}{\partial x} & 0 & \frac{\partial h_3}{\partial x} & 0 & \frac{\partial h_4}{\partial x} & 0 \\ 0 & \frac{\partial h_1}{\partial y} & 0 & \frac{\partial h_2}{\partial y} & 0 & \frac{\partial h_3}{\partial y} & 0 & \frac{\partial h_4}{\partial y} \\ \frac{\partial h_1}{\partial y} & \frac{\partial h_1}{\partial x} & \frac{\partial h_2}{\partial y} & \frac{\partial h_2}{\partial x} & \frac{\partial h_3}{\partial y} & \frac{\partial h_3}{\partial x} & \frac{\partial h_4}{\partial y} & \frac{\partial h_4}{\partial x} \end{pmatrix} \begin{pmatrix} u_1 \\ v_1 \\ u_2 \\ v_2 \\ u_3 \\ v_3 \\ u_4 \\ v_4 \end{pmatrix}$$

$\epsilon = \quad \quad \quad \mathbf{B} \quad \quad \mathbf{u}$

(2-9-6)

In the plane stress problem, the stress-strain relationship is expressed as,

$$\begin{pmatrix} \sigma_x \\ \sigma_y \\ \tau_{xy} \end{pmatrix} = \frac{E}{1-\nu} \begin{pmatrix} 1 & \nu & 0 \\ \nu & 1 & 0 \\ 0 & 0 & \frac{1-\nu}{2} \end{pmatrix} \begin{pmatrix} \varepsilon_x \\ \varepsilon_y \\ \gamma_{xy} \end{pmatrix} \quad (2-9-7)$$

$$\sigma = C \varepsilon$$

Substituting equation (2-9-6) into equation (2-9-7),

$$\sigma = C B u \quad (2-9-8)$$

From the Principle of Virtual Work Method,

$$\int_V (B\bar{u})^T (CBu) dv = \bar{u}^T \left(\int_{V(x,y)} B^T CB dx dy \right) u = \bar{u}^T F \quad (2-9-9)$$

Therefore, the stiffness equation is obtained as,

$$F = Ku, \quad K = \int_V B^T CB dv \quad (2-9-10)$$

If we assume the constant thickness of the plate (= t), using the relation $dv = t dx dy$,

$$K = t \int_{V(x,y)} B^T CB dx dy \quad (2-9-11)$$

Since this integration is defined in x-y coordinate, we must transfer the coordinate into r-s coordinate to use the numerical integration method. Introducing the **Jacobian matrix**,

$$J = \begin{pmatrix} \frac{\partial x}{\partial r} & \frac{\partial y}{\partial r} \\ \frac{\partial x}{\partial s} & \frac{\partial y}{\partial s} \end{pmatrix}; \text{ Jacobian Matrix} \quad (2-9-12)$$

the above integration is expressed in r-s coordinate as,

$$K = t \int_{-1}^1 \int_{-1}^1 B(x(r,s), y(r,s))^T CB(x(r,s), y(r,s)) \frac{\partial(x,y)}{\partial(r,s)} dr ds \quad (2-9-13)$$

where

$$\frac{\partial(x,y)}{\partial(r,s)} = \det J = \begin{vmatrix} \frac{\partial x}{\partial r} & \frac{\partial y}{\partial r} \\ \frac{\partial x}{\partial s} & \frac{\partial y}{\partial s} \end{vmatrix} \quad (2-9-14)$$

Evaluation of Jacobian Matrix

$$J = \begin{pmatrix} \frac{\partial x}{\partial r} & \frac{\partial y}{\partial r} \\ \frac{\partial x}{\partial s} & \frac{\partial y}{\partial s} \end{pmatrix} = \begin{pmatrix} \sum_{i=1}^4 \frac{\partial h_i}{\partial r} x_i & \sum_{i=1}^4 \frac{\partial h_i}{\partial r} y_i \\ \sum_{i=1}^4 \frac{\partial h_i}{\partial s} x_i & \sum_{i=1}^4 \frac{\partial h_i}{\partial s} y_i \end{pmatrix} \quad (2-9-15)$$

Evaluation of the matrix B

$$B = \begin{pmatrix} \frac{\partial h_1}{\partial x} & 0 & \frac{\partial h_2}{\partial x} & 0 & \frac{\partial h_3}{\partial x} & 0 & \frac{\partial h_4}{\partial x} & 0 \\ 0 & \frac{\partial h_1}{\partial y} & 0 & \frac{\partial h_2}{\partial y} & 0 & \frac{\partial h_3}{\partial y} & 0 & \frac{\partial h_4}{\partial y} \\ \frac{\partial h_1}{\partial y} & \frac{\partial h_1}{\partial x} & \frac{\partial h_2}{\partial y} & \frac{\partial h_2}{\partial x} & \frac{\partial h_3}{\partial y} & \frac{\partial h_3}{\partial x} & \frac{\partial h_4}{\partial y} & \frac{\partial h_4}{\partial x} \end{pmatrix} \quad (2-9-16)$$

The derivatives $\frac{\partial h_1}{\partial x}, \dots, \frac{\partial h_4}{\partial x}, \frac{\partial h_1}{\partial y}, \dots, \frac{\partial h_4}{\partial y}$ are calculated as,

$$\begin{aligned} \frac{\partial h_1}{\partial x} &= \frac{\partial h_1}{\partial r} \frac{\partial r}{\partial x} + \frac{\partial h_1}{\partial s} \frac{\partial s}{\partial x}, \quad \dots, \quad \frac{\partial h_4}{\partial x} = \frac{\partial h_4}{\partial r} \frac{\partial r}{\partial x} + \frac{\partial h_4}{\partial s} \frac{\partial s}{\partial x}, \\ \frac{\partial h_1}{\partial y} &= \frac{\partial h_1}{\partial r} \frac{\partial r}{\partial y} + \frac{\partial h_1}{\partial s} \frac{\partial s}{\partial y}, \quad \dots, \quad \frac{\partial h_4}{\partial y} = \frac{\partial h_4}{\partial r} \frac{\partial r}{\partial y} + \frac{\partial h_4}{\partial s} \frac{\partial s}{\partial y} \end{aligned}$$

In a matrix form,

$$\begin{aligned} \begin{pmatrix} \frac{\partial h_1}{\partial x} & \frac{\partial h_2}{\partial x} & \frac{\partial h_3}{\partial x} & \frac{\partial h_4}{\partial x} \\ \frac{\partial h_1}{\partial y} & \frac{\partial h_2}{\partial y} & \frac{\partial h_3}{\partial y} & \frac{\partial h_4}{\partial y} \end{pmatrix} &= \begin{pmatrix} \frac{\partial r}{\partial x} & \frac{\partial s}{\partial x} \\ \frac{\partial r}{\partial y} & \frac{\partial s}{\partial y} \end{pmatrix} \begin{pmatrix} \frac{\partial h_1}{\partial r} & \frac{\partial h_2}{\partial r} & \frac{\partial h_3}{\partial r} & \frac{\partial h_4}{\partial r} \\ \frac{\partial h_1}{\partial s} & \frac{\partial h_2}{\partial s} & \frac{\partial h_3}{\partial s} & \frac{\partial h_4}{\partial s} \end{pmatrix} \\ &= J^{-1} \begin{pmatrix} \frac{\partial h_1}{\partial r} & \frac{\partial h_2}{\partial r} & \frac{\partial h_3}{\partial r} & \frac{\partial h_4}{\partial r} \\ \frac{\partial h_1}{\partial s} & \frac{\partial h_2}{\partial s} & \frac{\partial h_3}{\partial s} & \frac{\partial h_4}{\partial s} \end{pmatrix} \end{aligned} \quad (2-9-17)$$

Evaluation of partial derivatives of the interpolation functions

$$\begin{aligned} \frac{\partial h_1}{\partial r} &= \frac{1}{4}(1+s) & \frac{\partial h_1}{\partial s} &= \frac{1}{4}(1+r) \\ \frac{\partial h_2}{\partial r} &= -\frac{1}{4}(1+s) & \frac{\partial h_2}{\partial s} &= \frac{1}{4}(1-r) \\ \frac{\partial h_3}{\partial r} &= -\frac{1}{4}(1-s) & \frac{\partial h_3}{\partial s} &= -\frac{1}{4}(1-r) \\ \frac{\partial h_4}{\partial r} &= \frac{1}{4}(1-s) & \frac{\partial h_4}{\partial s} &= -\frac{1}{4}(1+s) \end{aligned}, \quad (2-9-18)$$

The **3 points Gauss Integration Formula** is defined as:

$$\int_{-1}^1 f(t) dt = 0.5556 f(-0.7746) + 0.8889 f(0) + 0.5556 f(0.7746) \quad (2-9-19)$$

$$= \alpha_1 f(t_1) + \alpha_2 f(t_2) + \alpha_3 f(t_3)$$

where,

$$\alpha_1 = 0.5556, \quad \alpha_2 = 0.8889, \quad \alpha_3 = 0.5556$$

$$t_1 = -0.7746, \quad t_2 = 0, \quad t_3 = 0.7746$$

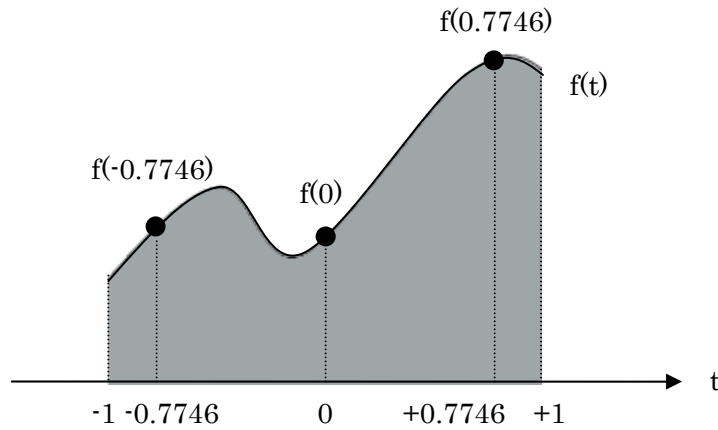

The stiffness matrix is then calculated numerically as follows:

$$K = t \int_{-1}^1 \int_{-1}^1 B(x(r,s), y(r,s))^T CB(x(r,s), y(r,s)) \frac{\partial(x,y)}{\partial(r,s)} dr ds$$

$$= t \int_{-1}^1 \int_{-1}^1 F(r,s) dr ds \quad (2-9-20)$$

$$= t \sum_{i=1}^3 \sum_{j=1}^3 \alpha_i \alpha_j F(r_i, s_j)$$

where

$$F(r,s) = B(x(r,s), y(r,s))^T CB(x(r,s), y(r,s)) \frac{\partial(x,y)}{\partial(r,s)}$$

$$\alpha_1 = 0.5556, \quad \alpha_2 = 0.8889, \quad \alpha_3 = 0.5556$$

$$r_1 = s_1 = -0.7746, \quad r_2 = s_2 = 0, \quad r_3 = s_3 = 0.7746$$

From global node displacement to element node displacement

Transformation from global node displacements to element node displacements is,

$$\begin{Bmatrix} u_1 \\ v_1 \\ u_2 \\ v_2 \\ u_3 \\ v_3 \\ u_4 \\ v_4 \end{Bmatrix} = [T_{iF}] \begin{Bmatrix} u_1 \\ u_2 \\ \vdots \\ u_n \end{Bmatrix} \quad (2-9-21)$$

The component of the transformation matrix, $[T_{iF}]$, is discussed in Chapter 4 (Freedom Vector).

3. Hysteresis model of nonlinear springs

Notation

a_t	:	Area of rebar in the tension side of the section
A_s	:	Total area of rebar in the section
σ_y	:	Strength of rebar
σ_B	:	Compression strength of concrete
σ_{wy}	:	Strength of shear reinforcement
D	:	Depth of the section
d	:	Effective depth of the section.
b	:	Width of the beam
j	:	Distance between the centers of stress in the section ($= (7/8)d$).
Z_e	:	Section modulus including the slab effect.
n	:	Ratio of Young's modulus ($= E_s / E_c$)
p_t	:	Tensile reinforcement ratio
p_w	:	Shear reinforcement ratio
I_e	:	Moment of inertia of section considering the slab effect
M_c	:	Crack moment
M_y	:	Yield moment
$M/(QD)$:	Shear span-to-depth ratio
θ_c	:	Crack rotation of the beam end
θ_y	:	Yield rotation of the beam end
ϕ_c	:	Crack rotation of the nonlinear bending spring
ϕ_y	:	Yield rotation of the nonlinear bending spring
k_0	:	Initial stiffness
k_y	:	Tangential stiffness at the yield point
k_{y2}	:	Stiffness after the yield point in the nonlinear bending spring
k_{y3}	:	Stiffness after the ultimate point in the nonlinear shear spring
α_y	:	Stiffness degradation factor at the yield point
Q_c	:	Crack shear force
Q_y	:	Yield shear force
Q_u	:	Ultimate shear force
x_s	:	Distance between the corner springs in the Multi-spring model

γ_c : Crack shear deformation
 γ_y : Yield shear deformation
 γ_u : Ultimate shear deformation

3.1 Beam

a) Section properties

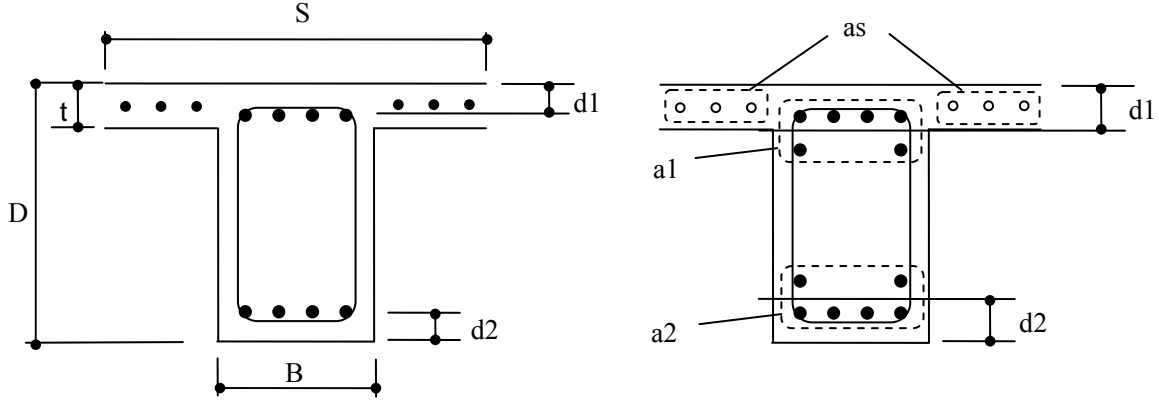

- B : Width of beam,
 D : Height of beam,
 S : Effective width of slab,
 t : Thickness of slab
 d1 : Distance to the center of upper main rebars,
 d2 : Distance to the center of bottom main rebars,
 a1 : Area of upper main rebars,
 a2 : Area of bottom main rebars
 as : Area of rebars in slab

Figure 3-1-1 Beam Section

Area of section to calculate axial deformation

$$A_N = BD + (S - B)t + (n_E - 1)(a_1 + a_2 + a_s) \quad (3-1-1)$$

where,

$$n_E = E_s / E_c \quad : \text{Ratio of Young's modulus between steel } (E_s) \text{ and concrete } (E_c)$$

Area of section to calculate shear deformation

$$A_S = BD \quad (3-1-2)$$

Moment of inertia around the center of the section

$$\begin{aligned}
 I_e = & \frac{BD^3}{12} + \frac{(S - B)t^3}{12} + BD \left(g - \frac{D}{2} \right)^2 + (S - B)t \left(D - \frac{t}{2} - g \right)^2 + \\
 & (n_E - 1)a_1(d_1 - g)^2 + (n_E - 1)a_2(D - d_2 - g)^2 + (n_E - 1)a_s \left(D - \frac{t}{2} - g \right)^2
 \end{aligned} \quad (3-1-3)$$

where, g is the center of beam section calculated by

$$g = \frac{BD^2 / 2 + (S - B)t(D - t/2) + (n_E - 1)(a_1d_1 + a_2(D - d_2) + a_s(D - t/2))}{A_N} \quad (3-1-4)$$

Effective width of slab is defined as shown in Figure 3-1-2.

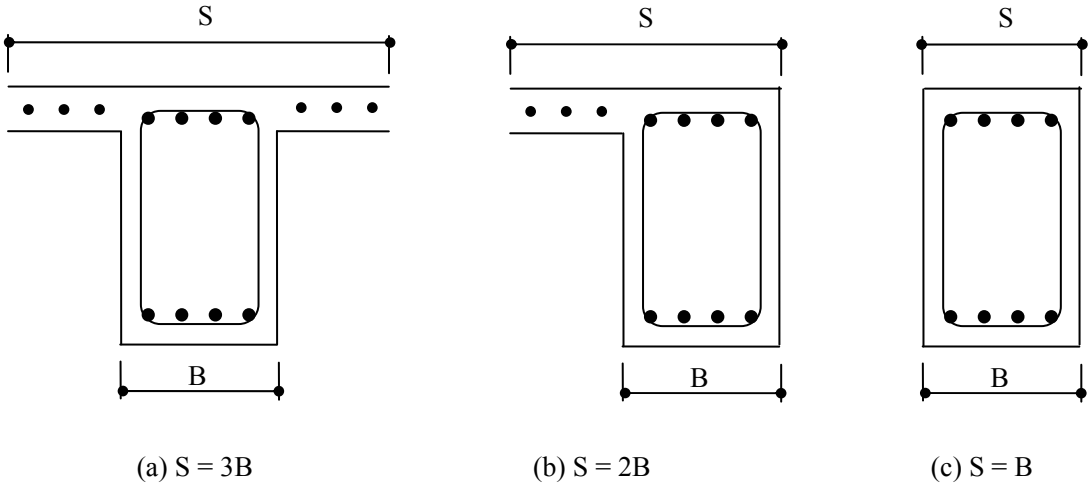

Figure 3-1-2 Effective width of slab

b) Nonlinear bending spring

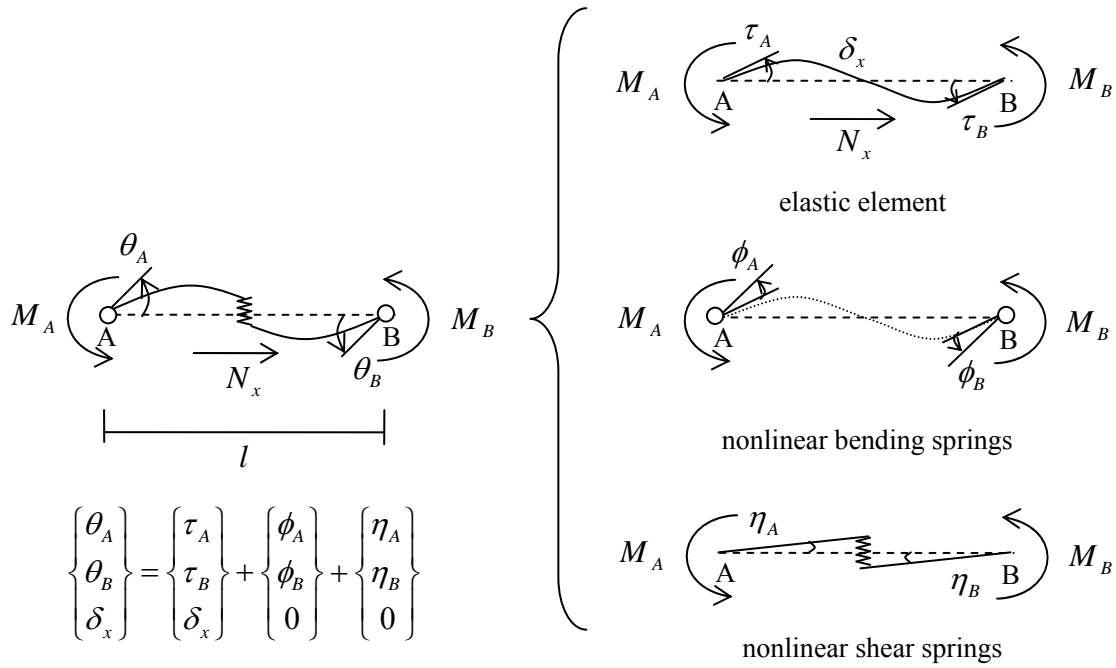

Figure 3-1-3 Element model for beam

Hysteresis model of a nonlinear bending spring is defined as the moment-rotation relationship under the anti-symmetry loading in Figure 3-1-4. The initial stiffness of the nonlinear spring is supposed to be infinite, however, in numerical calculation, a large enough value is used for the stiffness.

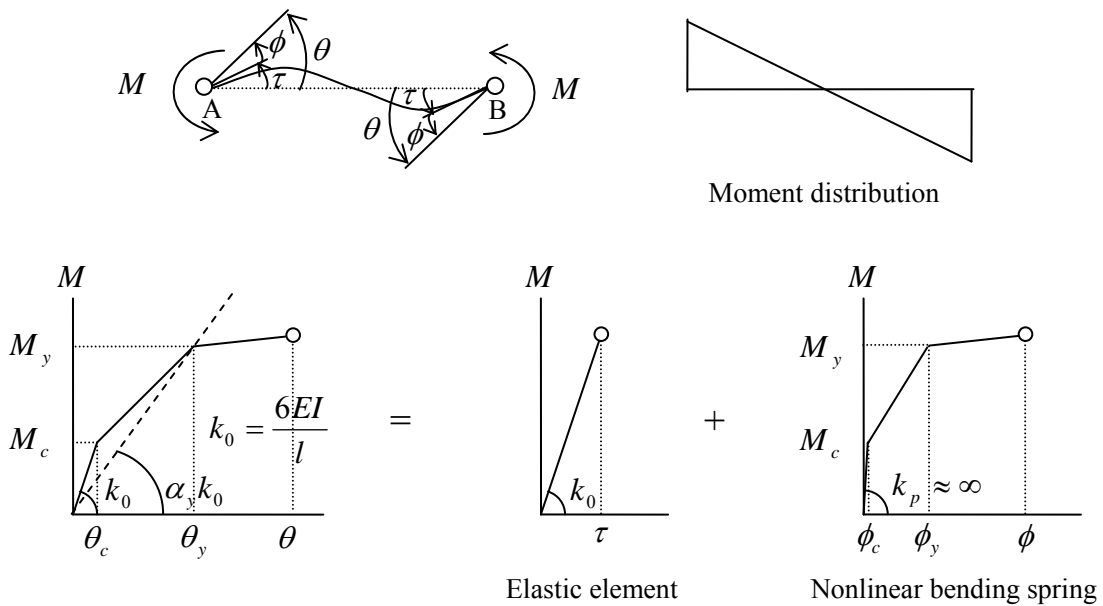

Figure 3-1-4 Moment – rotation relationship at bending spring

Crack moment force

For reinforced concrete elements, the crack moment, M_c is calculated as,

$$M_{c1} = 0.56\sqrt{\sigma_B} Z_{e1}, \quad Z_{e1} = I_e / g \quad \text{when tension in bottom main rebars} \quad (3-1-5)$$

$$M_{c2} = 0.56\sqrt{\sigma_B} Z_{e2}, \quad Z_e = I_e / (D - g) \quad \text{when tension in upper main rebars} \quad (3-1-6)$$

where,

$$\begin{aligned} \sigma_B & : && \text{Compression strength of concrete (N/mm}^2\text{)} \\ Z_{e1}, Z_{e2} & : && \text{Section modulus} \end{aligned}$$

Yield moment force

The yield moment, M_y is calculated as,

$$M_{y1} = 0.9a_1\sigma_y(D - d_1) \quad \text{when tension in bottom main rebars} \quad (3-1-7)$$

$$M_{y1} = 0.9a_2\sigma_y(D - d_2) + 0.9a_s\sigma_y(D - t/2) \quad \text{when tension in upper main rebars} \quad (3-1-8)$$

where,

$$\sigma_y \quad : \quad \text{Strength of rebar (N/mm}^2\text{)}$$

Yield rotation

The tangential stiffness at the yield point, k_y , is obtained from the following equation.:

$$k_y = \alpha_y k_0, \quad k_0 = \frac{6E_c I_e}{l} \quad (3-1-9)$$

where,

α_y is the stiffness degradation factor at the yield point, which is obtained from the following empirical formulas:

$$\alpha_y = (0.043 + 1.63np_t + 0.043a/D)(d/D)^2, \quad (a/D \leq 2) \quad (3-1-10)$$

$$\alpha_y = (-0.0836 + 0.159a/D)(d/D)^2, \quad (a/D > 2) \quad (3-1-11)$$

where,

$$\begin{aligned} p_t & : && \text{Tensile reinforcement ratio} \\ & && p_t = a_1/(BD) \quad \text{(when tension in bottom main rebars)} \\ & && p_t = (a_2 + a_s)/(BD) \quad \text{(when tension in upper main rebars)} \\ a/D & : && \approx \text{Shear span-to-depth ratio } (=l/(2D)) \\ d & : && \text{effective depth} \\ & && d = D - d_1 \quad \text{(when tension in bottom main rebars)} \\ & && d = D - d_2 \quad \text{(when tension in upper main rebars)} \end{aligned}$$

α_y is modified in case of tension in upper main rebars as

$$\alpha_y' = \alpha_y \frac{I_{e0}}{I_e} \quad (3-1-12)$$

where $I_{e0} = \frac{BD^3}{12}$: the moment of inertia of square section without slab

The yield rotation of the nonlinear bending beam, ϕ_y , is then obtained from,

$$\phi_y = \left(\frac{1}{\alpha_y} - 1 \right) \frac{M_y}{k_0} \quad (3-1-13)$$

Crack rotation

From Figure 3-1-2, the crack rotation of the nonlinear bending beam, ϕ_c , is supposed to be zero value, however, in STERA_3D program, it is assumed as,

$$\phi_c = 0.001\phi_y \quad (3-1-14)$$

Slab effect

In case the size of slab is not specified, slab effect is approximately considered using the factor, $\alpha_s = 1.2$ as follows:

$$I_e = \alpha_s^2 I_0, \quad I_0 = \frac{bD^3}{12} \quad : \text{Moment of inertia of section} \quad (3-1-15)$$

$$Z_e = (\alpha_s)^{3/2} Z_0, \quad Z_0 = \frac{bD^2}{6} \quad : \text{Section modulus} \quad (3-1-16)$$

$$A_e = \alpha_s A_0, \quad A_0 = bD \quad : \text{Section} \quad (3-1-17)$$

Hysteresis model

To consider the difference of the flexural capacity between positive and negative side of the beam, a degrading tri-linear model is developed based on the Takeda Model for the hysteresis model of the bending springs of the beam.

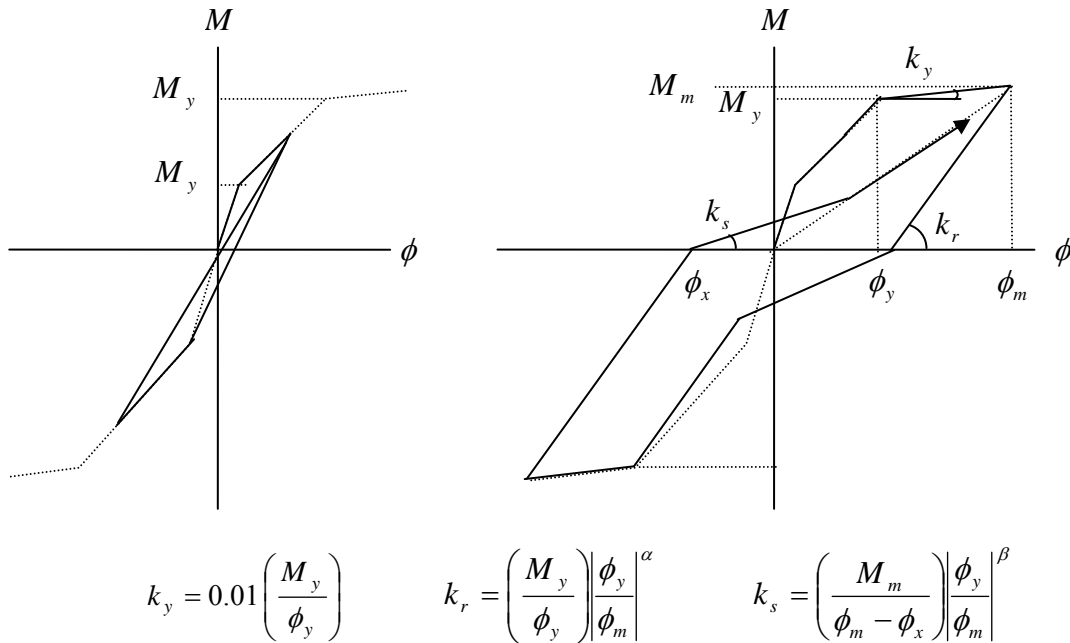

Figure 3-1-4 Degrading Tri-linear Model
($\alpha=0.5$ and $\beta=0.0$ as default values)

The strength degradation under cyclic loading is considered by elongating the target displacement, ϕ_m , to be ϕ'_m as shown in the following Figure:

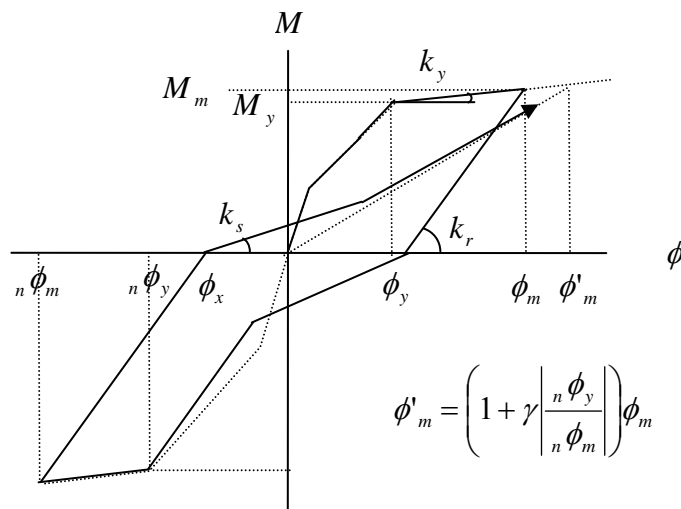
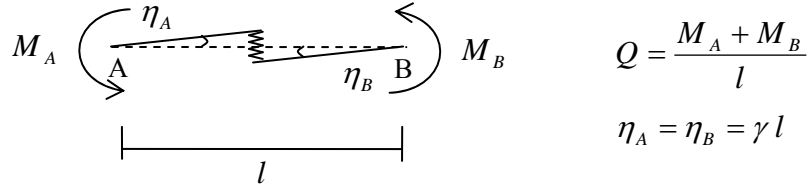

Figure 3-1-5 Introducing strength degradation ($\gamma=0.0$ as default value)

c) Nonlinear shear spring

Hysteresis model of nonlinear shear spring is defined as the shear force – shear rotation relationship using an origin-oriented poly-linear model as shown in Figure 3-1-4.



nonlinear shear springs

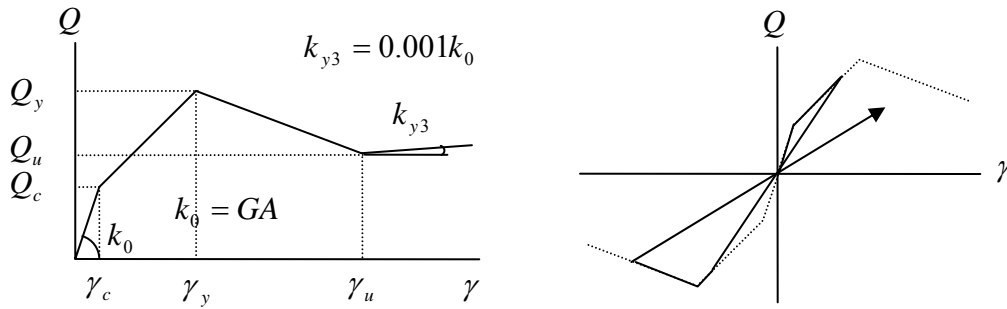

Figure 3-1-6 Force–deformation relationship of shear spring

Yield shear force

The yield shear force, Q_y is calculated as,

$$Q_y = \left\{ \frac{0.053 p_t^{0.23} (\sigma_B + 18)}{M / (QD) + 0.12} + 0.85 \sqrt{p_w \cdot \sigma_{wy}} \right\} b \cdot j \quad (3-1-18)$$

where,

- p_t : Tensile reinforcement ratio
- σ_B : Compression strength of concrete
- p_w : Shear reinforcement ratio
- σ_{wy} : Strength of shear reinforcement
- j : Distance between the centers of stress in the section ($= (7/8)d$).

Crack shear force

The crack shear force is, Q_c , is assumed as,

$$Q_c = \frac{Q_y}{3} \quad (3-1-19)$$

Ultimate shear force

The crack shear force is, Q_u , is assumed as,

$$Q_u = Q_c \quad (3-1-20)$$

Crack shear deformation

The crack shear deformation is obtained as,

$$\gamma_c = \frac{Q_c}{GA} \quad (3-1-21)$$

Yield shear displacement

The yield shear deformation is assumed as,

$$\gamma_y = \frac{1}{250} \quad (3-1-22)$$

Ultimate shear displacement

The ultimate shear deformation is assumed as,

$$\gamma_u = \frac{1}{100} \quad (3-1-23)$$

d) Modification of initial stiffness of nonlinear springs

In numerical calculation, a large dummy value is used for the initial stiffness of the nonlinear spring to represent rigid condition. This large stiffness may cause an error for estimating the force from the displacement. One possible way to solve the problem is to reduce the initial stiffness of the nonlinear spring to be a certain value reasonable for calculation, and on the other hand, increase the stiffness of the elastic element so that the total initial stiffness of the beam element does not change from the original one. This idea is proposed by K-N Li (2004) for MS model, and can be used for nonlinear spring model also.

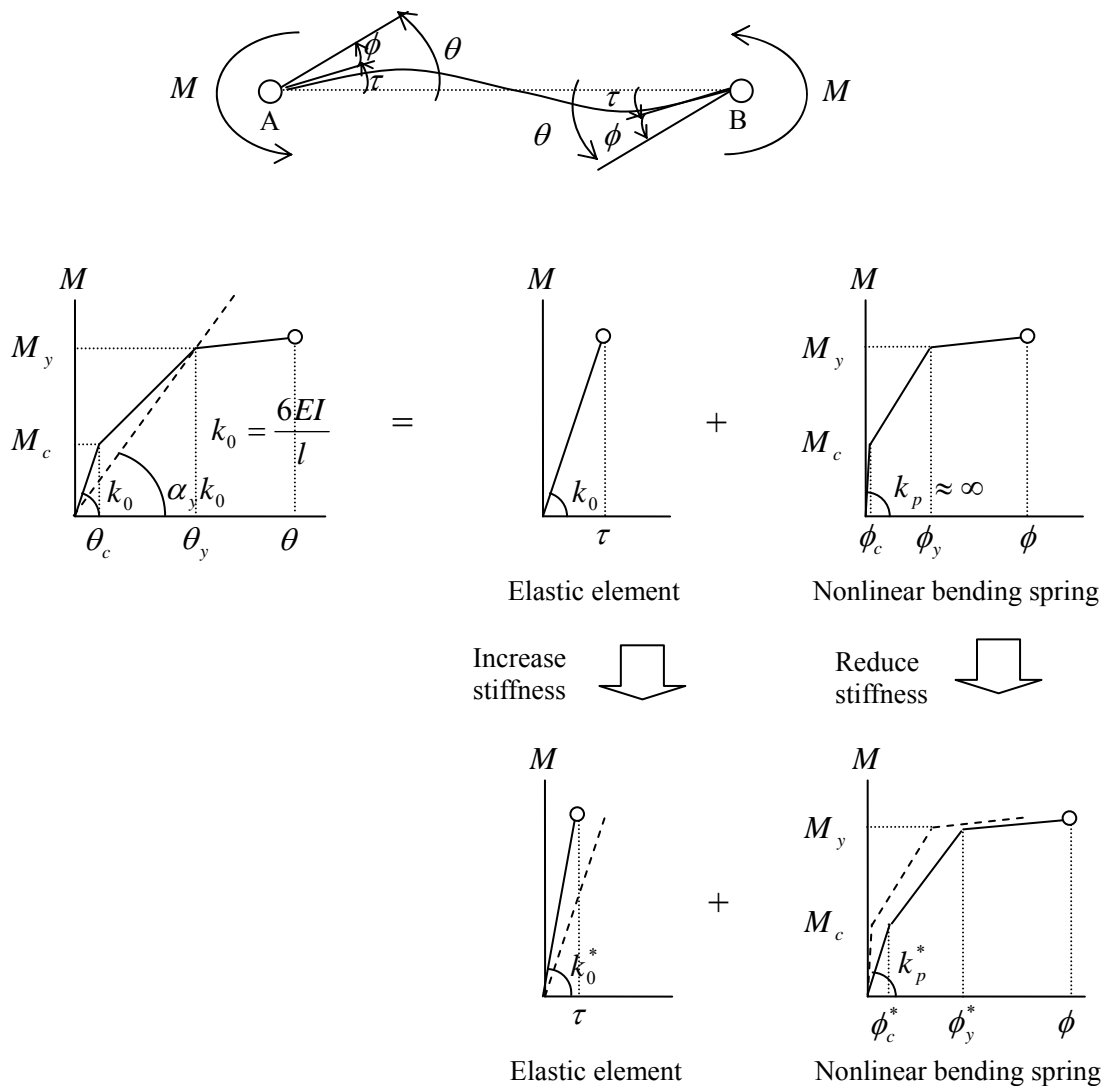

Figure 3-1-7 Modification of moment – rotation relationship

The idea is realized using flexibility reduction factors, $\gamma_1 (< 0)$, $\gamma_2 (< 0)$, in the relationship between the displacement vector and force vector of the elastic element in Equation (2-1-1) as,

$$\begin{Bmatrix} \tau'_{yA} \\ \tau'_{yB} \\ \delta'_x \end{Bmatrix} = \begin{bmatrix} \gamma_1 \frac{l'}{3EI_y} & -\frac{l'}{6EI_y} & 0 \\ -\frac{l'}{6EI_y} & \gamma_2 \frac{l'}{3EI_y} & 0 \\ 0 & 0 & \frac{l'}{EA} \end{bmatrix} \begin{Bmatrix} M'_{yA} \\ M'_{yB} \\ N'_x \end{Bmatrix} \quad (3-1-24)$$

It must be $\gamma_1 \frac{l'}{3EI_y} > \frac{l'}{6EI_y}$ or $\gamma_1 > 0.5$ and $\gamma_2 \frac{l'}{3EI_y} > \frac{l'}{6EI_y}$ or $\gamma_2 > 0.5$.

Also the initial flexibility matrix of the nonlinear spring can be expressed as follows, introducing the parameters, p_1, p_2 to increase the initial flexibility.

$$\begin{Bmatrix} \phi_{yA} \\ \phi_{yB} \end{Bmatrix} = \begin{bmatrix} p_1/EI & 0 \\ 0 & p_2/EI \end{bmatrix} \begin{Bmatrix} M'_{yA} \\ M'_{yB} \end{Bmatrix} \quad (3-1-25)$$

When $p_1 \rightarrow 0, p_2 \rightarrow 0$, it represents the infinite stiffness for rigid condition. Accordingly, the crack and yield rotation will be modified as,

$$\phi_c^* = p_1 \frac{M_c}{EI}, \quad \phi_y^* = \left(\frac{1}{\alpha_y} - \frac{1}{\gamma_1} \right) \frac{M_y}{k_0} \quad (3-1-26)$$

Making the modified flexibility matrix to be identical to the original one,

$$\begin{bmatrix} \frac{l'}{3EI_y} & -\frac{l'}{6EI_y} & 0 \\ & \frac{l'}{3EI_y} & 0 \\ sym. & & \frac{l'}{EA} \end{bmatrix}_{original} = \begin{bmatrix} \frac{p_1}{EI} + \gamma_1 \frac{l'}{3EI_y} & -\frac{l'}{6EI_y} & 0 \\ & \frac{p_2}{EI} + \gamma_2 \frac{l'}{3EI_y} & 0 \\ sym. & & \frac{l'}{EA} \end{bmatrix}_{modified} \quad (3-1-27)$$

This gives the flexivity reduction factors as:

$$\gamma_1 = 1 - \frac{3}{l'} p_1, \quad \gamma_2 = 1 - \frac{3}{l'} p_2 \quad (3-1-28)$$

From the conditions $\gamma_1 > 0.5$ and $\gamma_2 > 0.5$,

$$p_1 < \frac{l'}{6}, \quad p_2 < \frac{l'}{6}$$

K-N Li (2004) calls these parameters, p_1, p_2 , as “plastic zones” and recommends to be $p_1 = p_2 = \frac{l'}{10}$.

Then the reduction factors will be $\gamma_1 = \gamma_2 = 0.7$.

3.2 Column

a) Section properties

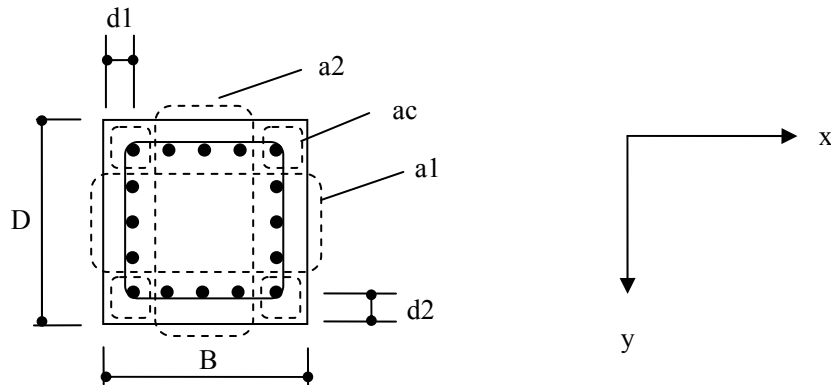

- B : Width of beam,
- D : Height of beam,
- d_1 : Distance to the center of x-direction main rebar,
- d_2 : Distance to the center of y-direction main rebar,
- a_1 : Area of x-side main rebar,
- a_2 : Area of y-side main rebar,
- a_c : Area of corner main rebar

Figure 3-2-1 Column Section

Area of section to calculate axial deformation

$$A_N = BD + (n_E - 1)(a_1 + a_2 + a_c) \quad (3-2-1)$$

Area of section to calculate shear deformation

$$A_S = BD / \kappa, \quad \kappa = 1.2 \quad (3-2-2)$$

Moment of inertia around the center of the section

$$I_y = \frac{DB^3}{12} + (n_E - 1)(a_c + a_1) \left(\frac{B}{2} - d_1 \right)^2 \quad (3-2-3)$$

$$I_x = \frac{BD^3}{12} + (n_E - 1)(a_c + a_2) \left(\frac{D}{2} - d_2 \right)^2 \quad (3-2-4)$$

b) Nonlinear bending spring

To consider nonlinear interaction among $M_x - M_y - N_z$, the nonlinear bending spring at the member end is constructed from the nonlinear vertical springs arranged in the member section as shown in Figure 3-2-2.

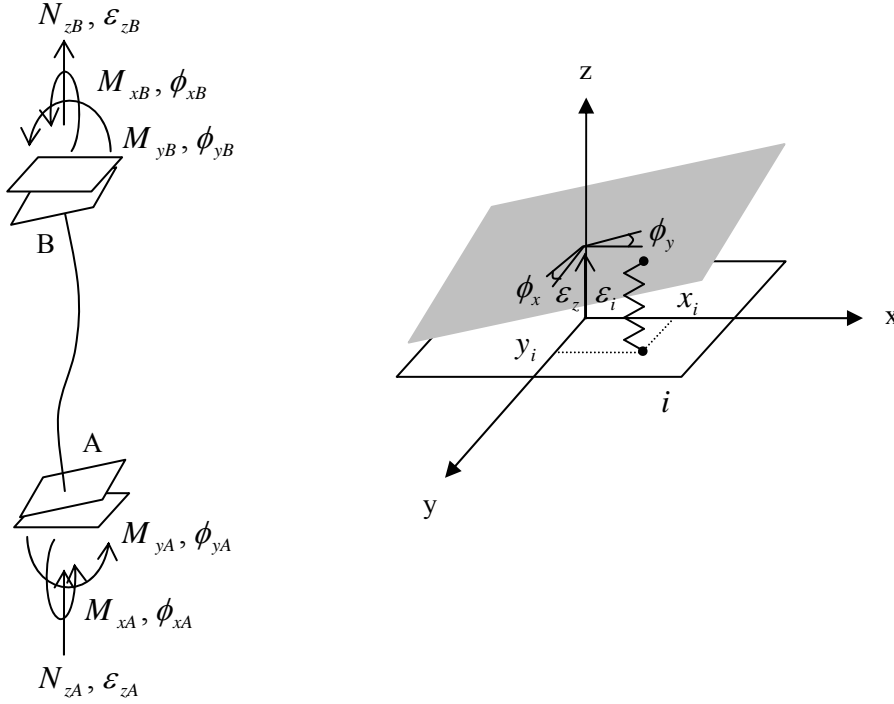

Figure 3-2-2 Nonlinear bending springs

Displacement of the i -th nonlinear axial spring is,

$$\varepsilon_i = \varepsilon_z - y_i \phi_x + x_i \phi_y \quad (3-2-5)$$

Equilibrium condition in the nonlinear section is,

$$\begin{aligned} M'_y &= \sum_i k_i \varepsilon_i x_i = \sum_i k_i (\varepsilon_z - y_i \phi_x + x_i \phi_y) x_i \\ M'_x &= -\sum_i k_i \varepsilon_i y_i = -\sum_i k_i (\varepsilon_z - y_i \phi_x + x_i \phi_y) y_i \\ N'_z &= \sum_i k_i \varepsilon_i = \sum_i k_i (\varepsilon_z - y_i \phi_x + x_i \phi_y) \end{aligned} \quad (3-2-6)$$

In a matrix form

$$\begin{Bmatrix} M'_y \\ M'_x \\ N'_z \end{Bmatrix} = \begin{bmatrix} \sum_i k_i x_i^2 & -\sum_i k_i x_i y_i & \sum_i k_i x_i \\ & \sum_i k_i y_i^2 & -\sum_i k_i y_i \\ \text{sym.} & & \sum_i k_i \end{bmatrix} \begin{Bmatrix} \phi_y \\ \phi_x \\ \varepsilon_z \end{Bmatrix} = [k_p] \begin{Bmatrix} \phi_y \\ \phi_x \\ \varepsilon_z \end{Bmatrix} \quad (3-2-7)$$

Therefore

$$\begin{Bmatrix} \phi_y \\ \phi_x \\ \varepsilon_z \end{Bmatrix} = [k_p]^{-1} \begin{Bmatrix} M'_y \\ M'_x \\ N'_z \end{Bmatrix} = [f_p] \begin{Bmatrix} M'_y \\ M'_x \\ N'_z \end{Bmatrix} \quad (3-2-8)$$

For both ends

$$\begin{Bmatrix} \phi_{yA} \\ \phi_{xA} \\ \varepsilon_{zA} \\ \phi_{yB} \\ \phi_{xB} \\ \varepsilon_{zB} \end{Bmatrix} = \begin{bmatrix} [f_{pA}] & 0 \\ 0 & [f_{pB}] \end{bmatrix} \begin{Bmatrix} M'_{yA} \\ M'_{xA} \\ N'_{zA} \\ M'_{yB} \\ M'_{xB} \\ N'_{zB} \end{Bmatrix} \quad (3-2-9)$$

Hysteresis model of nonlinear bending spring is defined as the moment-rotation relationship under the anti-symmetry loading in Figure 3-2-2. The initial stiffness of the nonlinear spring is supposed to be infinite, however, in numerical calculation, a large enough value is used for the stiffness.

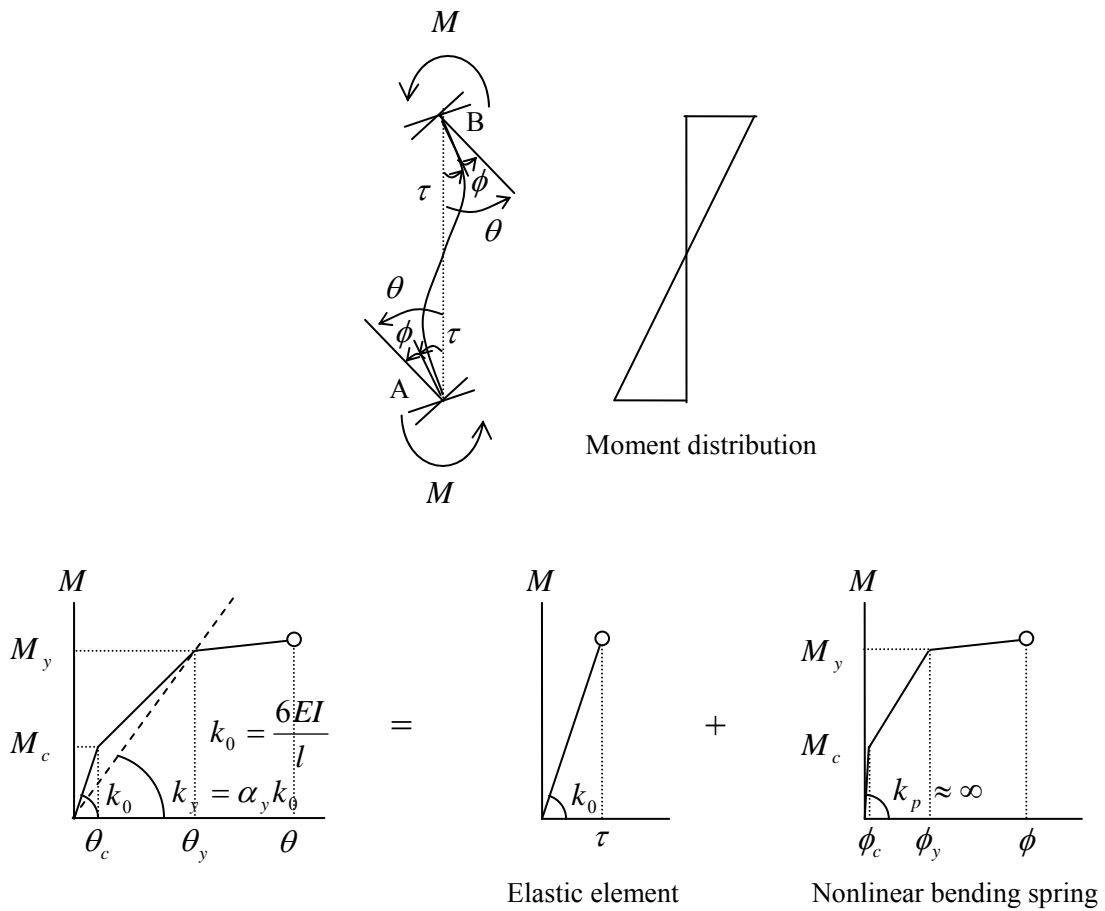

Figure 3-2-2 Moment – rotation relationship at bending spring

For reinforced concrete elements, the crack moment, M_c is calculated as,

$$M_c = 0.56\sqrt{\sigma_B}Z_e + \frac{ND}{6} \quad (3-2-10)$$

The yield moment, M_y is calculated from the following formula under the balance axial force, N_b ,

$$M_y = 0.8a_t\sigma_y D + 0.5N_b D \left(1 - \frac{N_b}{bD\sigma_B}\right) \quad (3-2-11)$$

$$N_b \approx 0.4bD\sigma_B \quad (3-2-12)$$

Note that the balance axial force, N_b , is used instead of actual axial force, N , in this formula since the characteristics of nonlinear vertical springs in a section are determined later from the equilibrium condition under the balance axial force.

The tangential stiffness at the yield point, k_y , is obtained from the following equation,:

$$k_y = \alpha_y K_0 \quad K_0 = \frac{6EI}{l} \quad (3-2-13)$$

where,

α_y is the stiffness degradation factor at the yield point, which is obtained from the following empirical formulas:

$$\alpha_y = (0.043 + 1.63np_t + 0.043a/D + 0.325\eta_b)(d/D)^2, \quad (a/D \leq 2) \quad (3-2-14)$$

$$\alpha_y = (-0.0836 + 0.159a/D + 0.169\eta_b)(d/D)^2, \quad (a/D > 2) \quad (3-2-15)$$

where,

p_t	:	Tensile reinforcement ratio
		$p_t = (a_c + a_1)/(2BD)$ (when tension in x-main rebars)
		$p_t = (a_c + a_2)/(2BD)$ (when tension in y-main rebars)
a/D	:	\approx Shear span-to-depth ratio ($=l/(2D)$)
d	:	effective depth
		$d = D - d1$ (when tension in bottom main rebars)
		$d = D - d2$ (when tension in upper main rebars)

$$k_y = \alpha_y K_0$$

$$\alpha_y = \left(0.043 + 1.63np_t + 0.043 \frac{M}{QD} + 0.33 \frac{N_b}{bD\sigma_B}\right) \left(\frac{d}{D}\right)^2, \quad K_0 = \frac{6EI}{l}$$

The yield rotation of the nonlinear bending beam, ϕ_y , is then obtained from,

$$\phi_y = \left(\frac{1}{\alpha_y} - 1 \right) \frac{M_y}{K_0} \quad (3-2-14)$$

c) Nonlinear vertical springs

The nonlinear bending spring is constructed from the nonlinear vertical springs arranged in the member section as shown in Figure 3-2-3. This model is called “Multi-spring model” proposed by S. S. Lai, G. T. Will and S. Otani (1984) and modified by K-N. Li (1988). The section is divided in 5 areas; where 4 corner areas have steel springs and concrete springs and the center area has one concrete spring.

The strength and the location of nonlinear springs are obtained from the equilibrium condition under the balance axial force, N_b , in Equation (3-2-8).

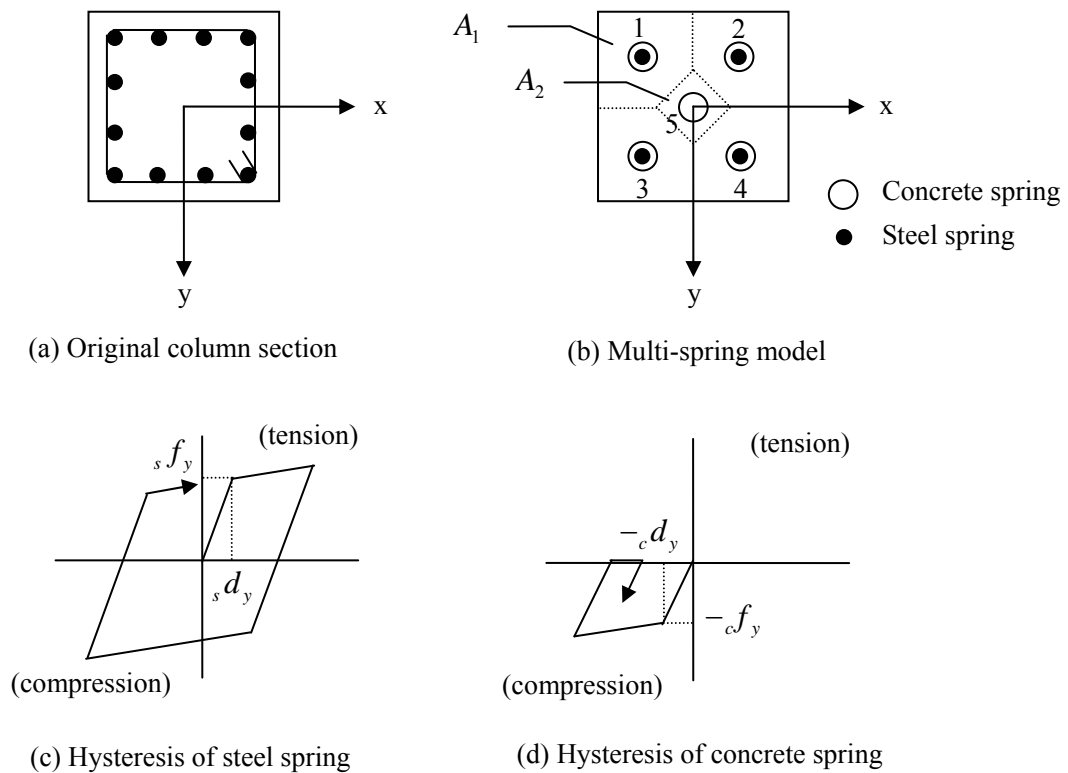

Figure 3-2-3 Nonlinear vertical springs

Strength of steel spring

The strength of the steel spring is one-fourth of total strength of rebars in the section, i.e.,

$${}_s f_y = \frac{A_s \sigma_y}{4} \quad (3-2-11)$$

where,

- A_s : Total area of rebar in the section
 σ_y : Strength of rebar

Strength of concrete spring

As shown in Figure 3-2-4, the strength of the corner concrete spring is obtained from the equilibrium condition in the vertical direction under the balance axial force, $N_b \approx -0.4bD\sigma_B$, that is,

$${}_c f_{y1} = \frac{N_b}{2} = 0.2bD\sigma_B \quad (3-2-12)$$

Therefore, the area of the corner concrete, A_1 , is,

$$A_1 = \frac{{}_c f_y}{(0.85\sigma_B)} \quad (3-2-13)$$

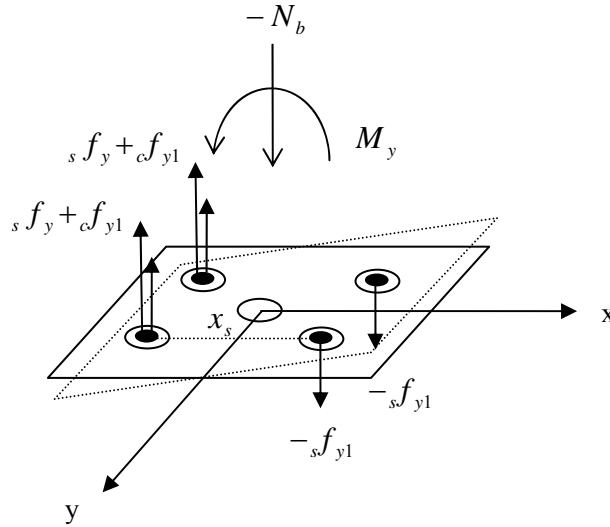

Figure 3-2-4 Equilibrium condition in the column section

The area of the center concrete, A_2 , is the rest of the area of the section,

$$A_2 = bD - 4A_1 \quad (> 0) \quad (3-2-14)$$

The strength of the center concrete spring is then obtained as,

$${}_c f_{y2} = 0.85k\sigma_B A_2 \quad (3-2-15)$$

where, k is the confined effect ($k = 1.3$) of the concrete.

Location of vertical springs

The distance between the corner springs, x_s , is obtained from the equilibrium condition regarding the moment force in Figure 3-2-4,

$$M_y = x_s(2_s f_y + c f_{y1}) = x_s(2_s f_y + 0.5N_b) \quad (3-2-16)$$

Therefore,

$$x_s = \frac{M_y}{2_s f_y + 0.5N_b} \quad (3-2-17)$$

Note that M_y is calculated from Equation (3-2-7) for the balance axial force, N_b .

Example)

To verify the efficiency of the Multi-Spring model for the column element, the M-N relationship is compared between MS-model and Theory using one column element. The column section is shown in the Figure below:

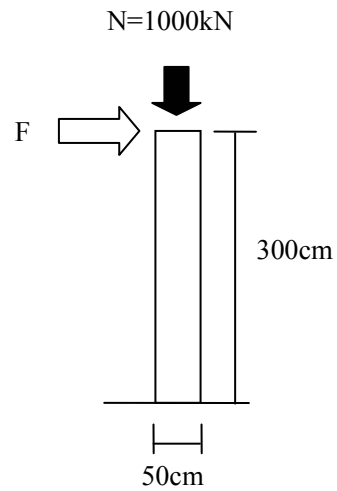
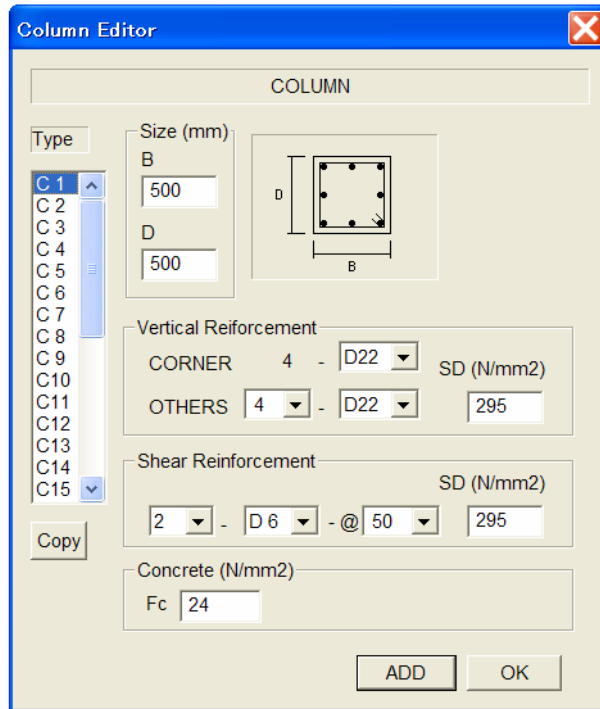

Figure 3-2-5

Theoretical results of the M-N relationship are obtained from the equilibrium condition as,
if ($0 < N \leq N_b$)

$$M_y = 0.8a_t\sigma_y D + 0.5ND \left(1 - \frac{N}{bD\sigma_B}\right) \quad (3-2-18)$$

if ($N_b < N \leq N_{\max}$)

$$M_y = \left(0.8a_t\sigma_y D + 0.12bD^2\sigma_B\right) \left(\frac{N_{\max} - N}{N_{\max} - N_b}\right) \quad (3-2-19)$$

where, N_b is the balance axial force,

$$N_b \approx 0.4bD\sigma_B \quad (3-2-20)$$

and N_{\max} is the maximum axial force,

$$N_{\max} \approx bD\sigma_B + A_s\sigma_y \quad (3-2-21)$$

Firstly, the strengths and locations of vertical springs are calculated from Equations (3-2-11), (3-2-12), (3-2-15) and (3-2-17).

$$a_t = 15.484 \text{ (cm}^2) \quad \sigma_y = 1.1 f_y = 32.45 \text{ (kN / cm}^2) \quad \sigma_B = 2.4 \text{ (kN / cm}^2)$$

$$N_b = 0.4bD\sigma_B = 2400 \text{ (kN)} \quad N_{\max} = bD\sigma_B + A_s\sigma_y = 6502 \text{ (kN)}$$

$${}_s f_y = 251.2 \text{ (kN)} \quad {}_c f_{y1} = 1200 \text{ (kN)} \quad {}_c f_{y2} = 390 \text{ (kN)} \quad x_s = 30 \text{ (cm)}$$

In the range $(0 < N \leq N_b)$, the Multi-Spring model gives

$$M_y = (2{}_s f_y + 0.5N)x_s$$

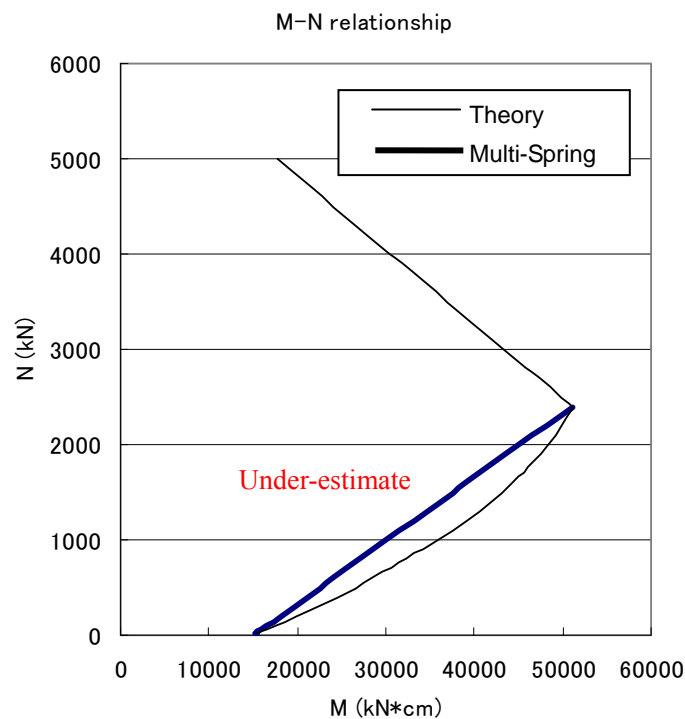

Figure 3-2-6 Comparison of M-N relationship

The results of Multi-Spring model give smaller values than theoretical results in the range $0 < N < N_b$.

K-N. Li (1988) proposed to use the following formulation for deciding the location of vertical springs in stead of Equation (3-2-17), as follows:

$$x_s = \frac{M_{y0}}{2_s f_y + 0.5 N_0} \quad (3-2-22)$$

where, N_0 is the axial force from the dead loads and the live loads acting on the column ($N_0 < N_b$), and M_{y0} is the yield moment under the axial force N_0 , that is:

$$M_{y0} = 0.8 a_t \sigma_y D + 0.5 N_0 D \left(1 - \frac{N_0}{b D \sigma_B} \right) \quad (3-2-23)$$

For the example column, assuming $N_0 = 1000$ (kN),

$$x_s = 35.8 \text{ (cm)}$$

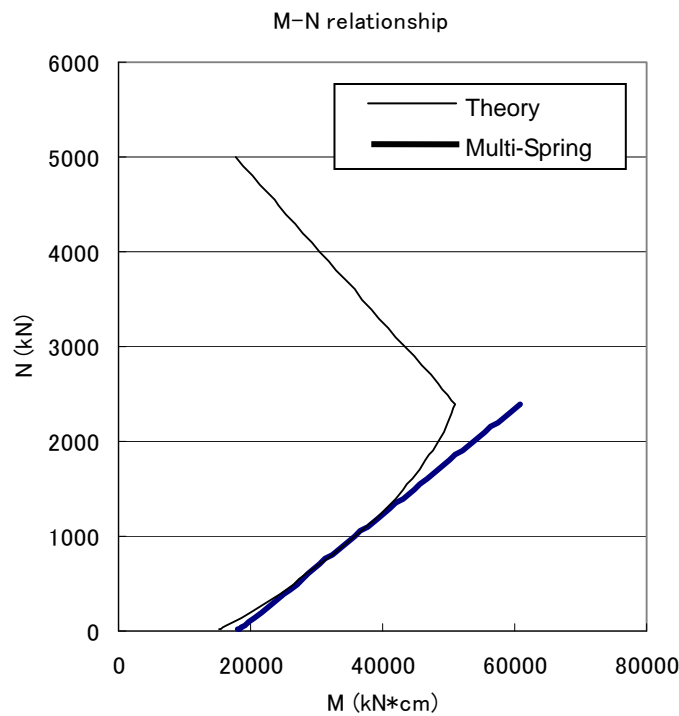

Figure 3-2-7 Comparison of M-N relationship

It improves the results of Multi-Spring model in the range $0 < N < N_b$.

Yield displacement of vertical spring

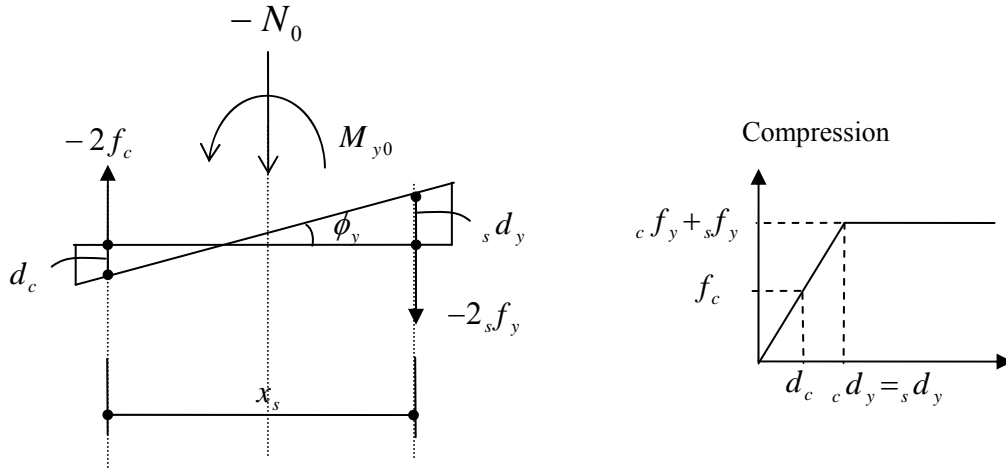

Figure 3-2-9 Equilibrium condition under the axial force N_0

From the equilibrium condition under the axial force N_0 as shown in the above Figure, the yield displacement of the tension side steel spring, $_s d_y$, is obtained as follows:

$$\begin{aligned}
 _s d_y + d_c &= \phi_y x_s \\
 d_c &= \frac{f_c}{_s f_y + _c f_y} _s d_y \\
 f_c &= \frac{N_0 + 2 _s f_y}{2} \\
 _s d_y &= \frac{\phi_y x_s}{1 + \frac{N_0 + 2 _s f_y}{2 _s f_y + 2 _c f_y}}
 \end{aligned} \tag{3-2-24}$$

The yield displacement of concrete spring, $_c d_y$, is assumed to be the same as that of the steel spring,

$$_c d_y = _s d_y \tag{3-2-25}$$

d) Nonlinear shear spring

There are two nonlinear shear springs in x and y directions. Hysteresis model of the nonlinear shear springs is the same as that in the beam element in Figure 3-1-4.

Yield shear force

The yield shear force, Q_y is calculated as,

$$Q_y = \left\{ \frac{0.053 p_t^{0.23} (\sigma_B + 18)}{M/(QD) + 0.12} + 0.85 \sqrt{p_w \cdot \sigma_{wy}} + 0.1 \sigma_0 \right\} b \cdot j \quad (3-2-26)$$

where,

p_t	:	Tensile reinforcement ratio
σ_B	:	Compression strength of concrete
$M/(QD)$:	\approx Shear span-to-depth ratio ($=l/(2D)$)
p_w	:	Shear reinforcement ratio
σ_{wy}	:	Strength of shear reinforcement
σ_0	:	Axial stress of the column
j	:	Distance between the centers of stress in the section ($= (7/8)d$).

Crack shear force

The crack shear force is, Q_c , is assumed as,

$$Q_c = \frac{Q_y}{3} \quad (3-2-27)$$

Ultimate shear force

The crack shear force is, Q_u , is assumed as,

$$Q_u = Q_c \quad (3-2-28)$$

Crack shear deformation

The crack shear deformation is obtained as,

$$\gamma_c = \frac{Q_c}{GA} \quad (3-2-29)$$

Yield shear displacement

The yield shear deformation is assumed as,

$$\gamma_y = \frac{1}{250} \quad (3-2-30)$$

Ultimate shear displacement

The ultimate shear deformation is assumed as,

$$\gamma_u = \frac{1}{100} \quad (3-2-31)$$

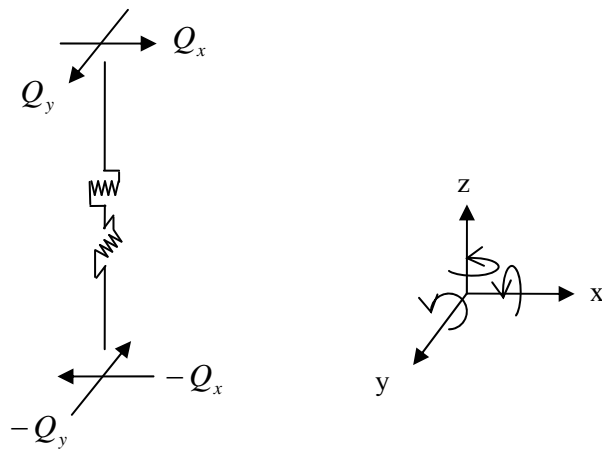

Figure 3-2-6 Nonlinear shear springs in column

e) **Modification of initial stiffness of nonlinear springs**

The same modification can be done for the nonlinear springs of column element as described for those of beam element by reducing the initial stiffness of the nonlinear spring and increasing the stiffness of the elastic element as shown in the following figure:

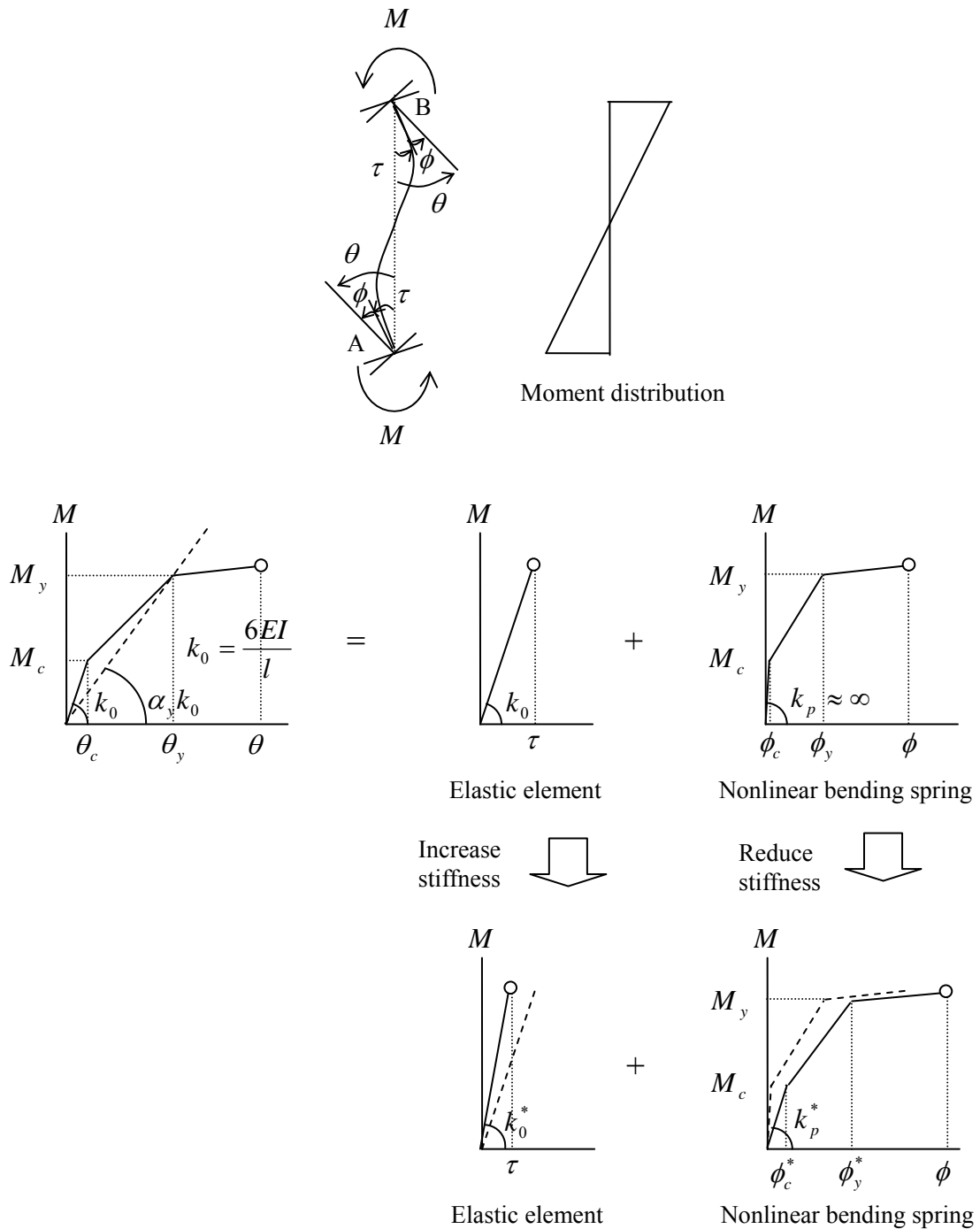

Figure 3-2-7 Modification of moment – rotation relationship

Introducing the concept of “plastic zones”, the initial stiffness of the i-th multi-spring can be expressed as,

$$k_0^i = \frac{E_i A_i}{p_z} \quad (3-2-32)$$

where E_i : the material young’s modulus, A_i : the spring governed area, and p_z : the length of assumed plastic zone. When $p_z \rightarrow 0$, it represents the infinite stiffness for rigid condition.

From Equation (3-2-7), when we consider the flexural flexibility in x-z plane, the flexibility matrix for the nonlinear MS section is,

$$\begin{Bmatrix} \phi_y \\ \varepsilon_z \end{Bmatrix} = \begin{bmatrix} 1/\sum_i k_0^i x_i^2 & 0 \\ 0 & 1/\sum_i k_0^i \end{bmatrix} \begin{Bmatrix} M'_y \\ N'_z \end{Bmatrix} = \begin{bmatrix} p_z/\sum_i E_i A_i x_i^2 & 0 \\ 0 & p_z/\sum_i E_i A \end{bmatrix} \begin{Bmatrix} M'_y \\ N'_z \end{Bmatrix} \quad (3-2-33)$$

Also, introducing the flexibility reduction factors, $\gamma_0 (< 0)$, $\gamma_1 (< 0)$, $\gamma_2 (< 0)$, the flexibility matrix of the elastic element is,

$$[f_c] = \begin{bmatrix} \gamma_1 \frac{l'}{3EI_y} & -\frac{l'}{6EI_y} \\ -\frac{l'}{6EI_y} & \gamma_2 \frac{l'}{3EI_y} \\ & & \gamma_0 \frac{l'}{EA} \end{bmatrix} \quad (3-2-34)$$

Making the modified flexibility matrix to be identical to the original one,

$$\begin{bmatrix} \frac{l'}{3EI_y} & -\frac{l'}{6EI_y} & 0 \\ & \frac{l'}{3EI_y} & 0 \\ sym. & & \frac{l'}{EA} \end{bmatrix}_{original} = \begin{bmatrix} \frac{p_{z1}}{\sum_i E_i A_i x_i^2} + \gamma_1 \frac{l'}{3EI_y} & -\frac{l'}{6EI_y} & 0 \\ & \frac{p_{z2}}{\sum_i E_i A_i x_i^2} + \gamma_2 \frac{l'}{3EI_y} & 0 \\ sym. & & \frac{p_{z1}}{\sum_i E_i A} + \frac{p_{z2}}{\sum_i E_i A} + \gamma_0 \frac{l'}{EA} \end{bmatrix}_{modified} \quad (3-2-35)$$

This gives the flexivity reduction factors as:

$$\gamma_1 = 1 - \frac{3}{l'} p_{z1}, \quad \gamma_2 = 1 - \frac{3}{l'} p_{z2}, \quad \gamma_0 = 1 - \frac{1}{l'} (p_{z1} + p_{z2}) \quad (3-2-36)$$

Adopting $p_{z1} = p_{z2} = \frac{l'}{10}$ as discussed for beam element, the reduction factors will be:

$$\gamma_1 = \gamma_2 = 0.7, \quad \gamma_0 = 0.8 \quad (3-2-37)$$

f) Tri-linear hysteresis for nonlinear springs

The original hysteresis models used for steel and concrete springs are bi-linear types as shown in Figure 3-2-3. To control both the initial stiffness and yield displacement, it is convenient to define tri-linear type hysteresis.

For the steel spring, the maximum-oriented model is adopted for the hysteresis before yielding, and the tri-linear model is adopted after yielding as shown in Figure 3-2-8.

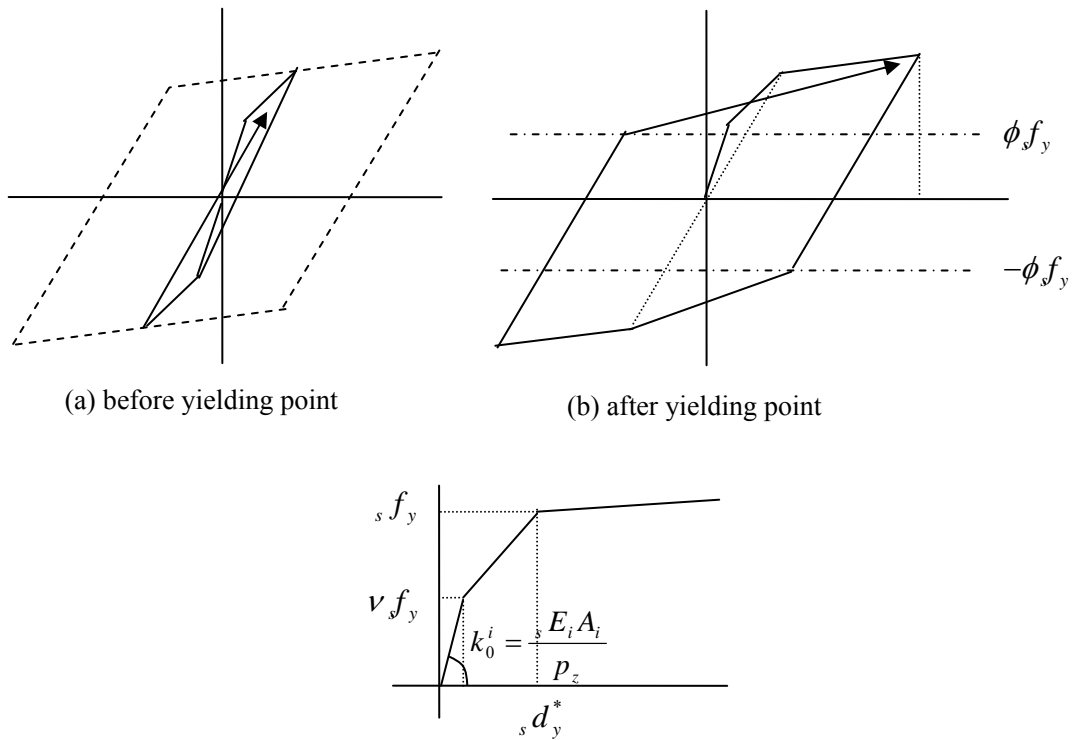

Figure 3-2-8 Normal tri-linear model for steel spring

The hysteresis of steel spring has the degradation point at the forces, νf_y and ϕf_y , where ν and ϕ are the arbitrary parameters ($\nu < 1$, $\phi < 1$). The STERA_3D Program adopts the values as:

$$\nu = 1/3, \quad \phi = 0.5 \quad (3-2-38)$$

Then, the yield deformation, ${}_s d_y^*$, may be obtained by Equations (3-2-24) and (3-2-10) considering the reduction factor γ .

$${}_s d_y = \frac{\phi_y^* x_s}{1 + \frac{N_0 + 2{}_s f_y}{2{}_s f_y + 2{}_c f_y}} \quad (3-2-39)$$

$$\phi_y^* = \left(\frac{1}{\alpha_y} - \frac{1}{\gamma} \right) \frac{M_y}{k_0} \quad (3-2-40)$$

The hysteresis of concrete spring is also defined as tri-linear hysteresis model as shown in Figure 3-2-9. After compression yielding, strength degradation is considered by reducing the strength of the target point in reloading stage.

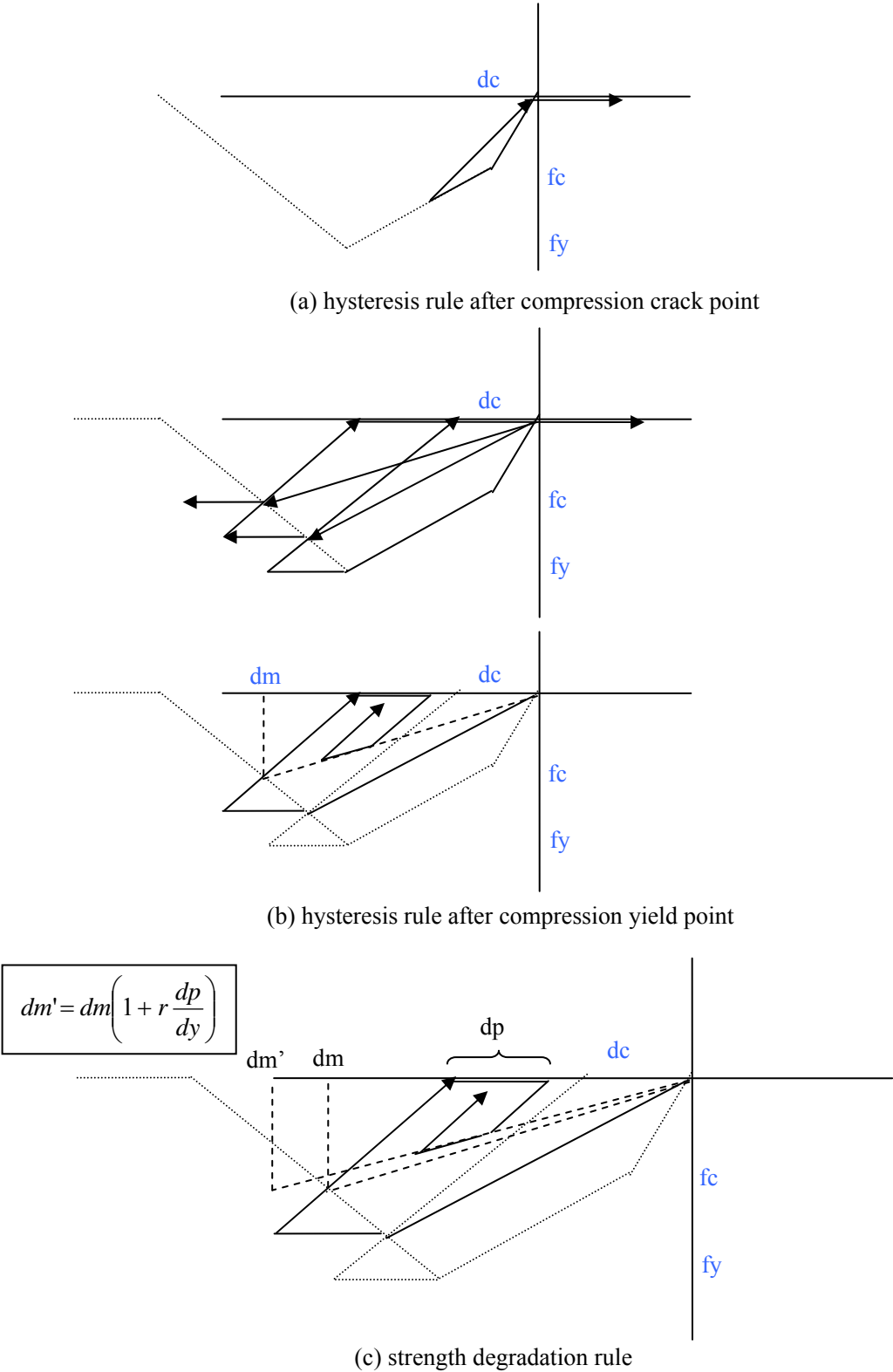

Figure 3-2-3 Tri-linear hysteresis model for concrete spring

References

- 1) S. S. Lai, G. T. Will, and S. Otani (1984), "Model for Inelastic Biaxial Bending of Concrete Members," Journal of Structural Division, ASCE, Vol. 110, ST1, 1984, pp.2563-2584.
- 2) K-N. Li (1988), "Nonlinear Earthquake Response of Reinforced Concrete Space Frames," the dissertation for the degree of Doctor in University of Tokyo (in Japanese), 1988.12.
- 3) K-N. Li (2004), CANNY, Technical Manual.

3.3 Wall

a) Section properties

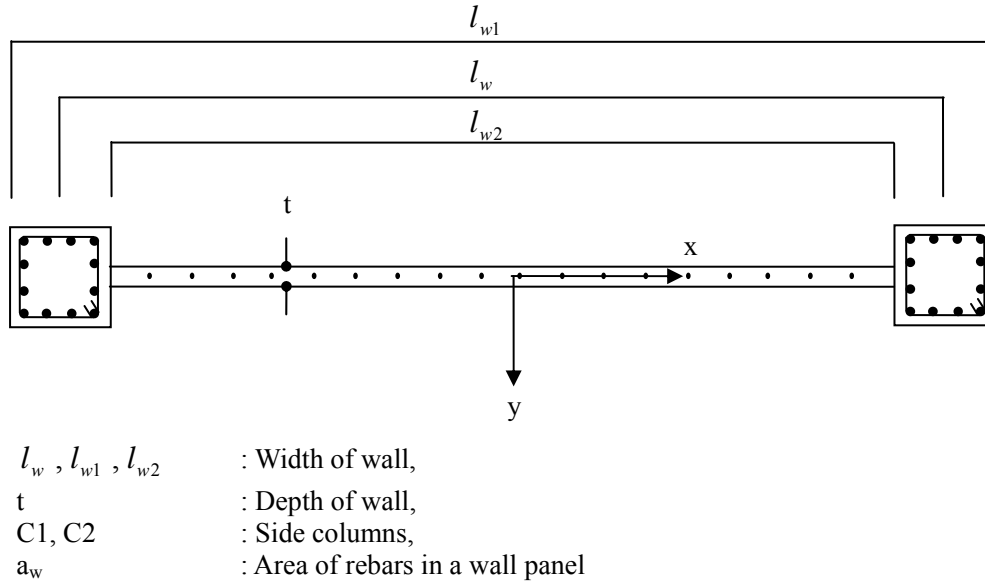

Figure 3-3-1 Wall Section

Area of section to calculate axial deformation

$$A_N = A_{N,C1} + A_{N,C2} + t l_{w2} + (n_E - 1)(a_w) \quad (3-3-1)$$

where,

$A_{N,C1}, A_{N,C2}$: Area of section of side columns for axial deformation

$n_E = E_s / E_c$: Ratio of Young's modulus between steel (E_s) and concrete (E_c)

Area of section to calculate shear deformation

$$A_S = A_{S,C1} + A_{S,C2} + t l_{w2} / \kappa, \quad \kappa = 1.2 \quad (3-3-2)$$

where,

$A_{S,C1}, A_{S,C2}$: Area of section of side columns for shear deformation

Moment of inertia around the center of the section

$$I_y = I_{y,C1} + I_{y,C2} + \frac{l_{w2} t^3}{12} + A_{N,C1} \left(\frac{l_{w1}}{2} \right)^2 + A_{N,C2} \left(\frac{l_{w1}}{2} \right)^2 \quad (3-3-3)$$

where,

$I_{y,C1}, I_{y,C2}$: Moment of inertia of side columns

b) Nonlinear bending spring

To consider nonlinear interaction among $M_x - M_y - N_z$, the nonlinear bending spring at the member end is constructed from the nonlinear vertical springs arranged in the member section as shown in Figure 3-3-2.

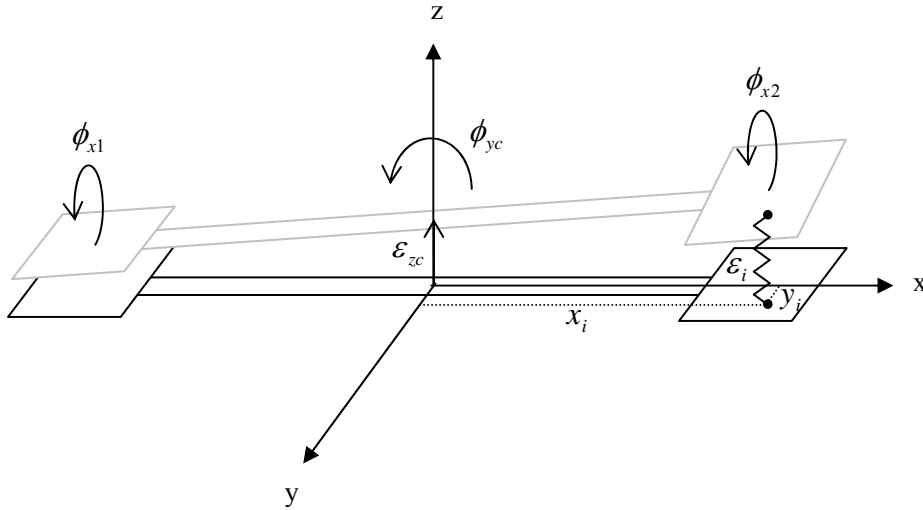

Figure 3-3-2 Nonlinear bending springs

Displacement of the i -th nonlinear axial spring is,

$$\begin{aligned}
 \varepsilon_i &= \varepsilon_{zc} + x_i \phi_{ye} && \text{in a wall panel} \\
 \varepsilon_i &= \varepsilon_{zc} - y_i \phi_{x1} + x_i \phi_{ye} && \text{in a side column 1} \\
 \varepsilon_i &= \varepsilon_{zc} - y_i \phi_{x2} + x_i \phi_{ye} && \text{in a side column 2}
 \end{aligned}
 \tag{3-3-4}$$

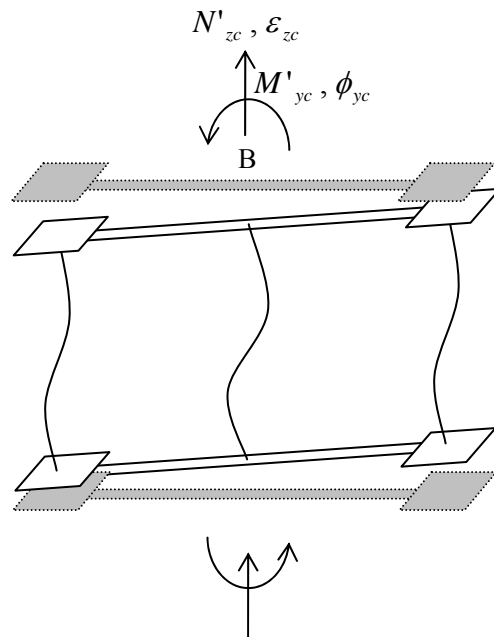

Figure 3-3-3 Equilibrium condition in the wall panel direction

In the wall panel direction, all vertical springs in the nonlinear section are assumed to work against the moment and the axial force. The equilibrium conditions are,

$$\begin{aligned}
 M'_{yc} &= \sum_i^{Nc} k_i \varepsilon_i x_i + \sum_i^{N1} k_i \varepsilon_i x_i + \sum_i^{N2} k_i \varepsilon_i x_i \\
 &= \sum_i^{Nc} k_i (\varepsilon_{zc} + x_i \phi_{yc}) x_i + \sum_i^{N1} k_i (\varepsilon_{zc} - y_i \phi_{x1} + x_i \phi_{yc}) x_i + \sum_i^{N2} k_i (\varepsilon_{zc} - y_i \phi_{x2} + x_i \phi_{yc}) x_i \\
 &= \begin{bmatrix} \sum_i^{Nc+N1+N2} k_i x_i^2 & -\sum_i^{N1} k_i x_i y_i & -\sum_i^{N2} k_i x_i y_i & \sum_i^{Nc+N1+N2} k_i x_i \end{bmatrix} \begin{Bmatrix} \phi_{yc} \\ \phi_{x1} \\ \phi_{x2} \\ \varepsilon_{zc} \end{Bmatrix}
 \end{aligned} \tag{3-3-5}$$

$$\begin{aligned}
 N'_{zc} &= \sum_i^{Nc} k_i \varepsilon_i + \sum_i^{N1} k_i \varepsilon_i + \sum_i^{N2} k_i \varepsilon_i \\
 &= \sum_i^{Nc} k_i (\varepsilon_{zc} + x_i \phi_{yc}) + \sum_i^{N1} k_i (\varepsilon_{zc} - y_i \phi_{x1} + x_i \phi_{yc}) + \sum_i^{N2} k_i (\varepsilon_{zc} - y_i \phi_{x2} + x_i \phi_{yc}) \\
 &= \begin{bmatrix} \sum_i^{Nc+N1+N2} k_i x_i & -\sum_i^{N1} k_i y_i & -\sum_i^{N2} k_i y_i & \sum_i^{Nc+N1+N2} k_i \end{bmatrix} \begin{Bmatrix} \phi_{yc} \\ \phi_{x1} \\ \phi_{x2} \\ \varepsilon_{zc} \end{Bmatrix}
 \end{aligned} \tag{3-3-6}$$

where, Nc , $N1$ and $N2$ are the number of vertical springs in a wall panel, side column 1 and side column 2, respectively.

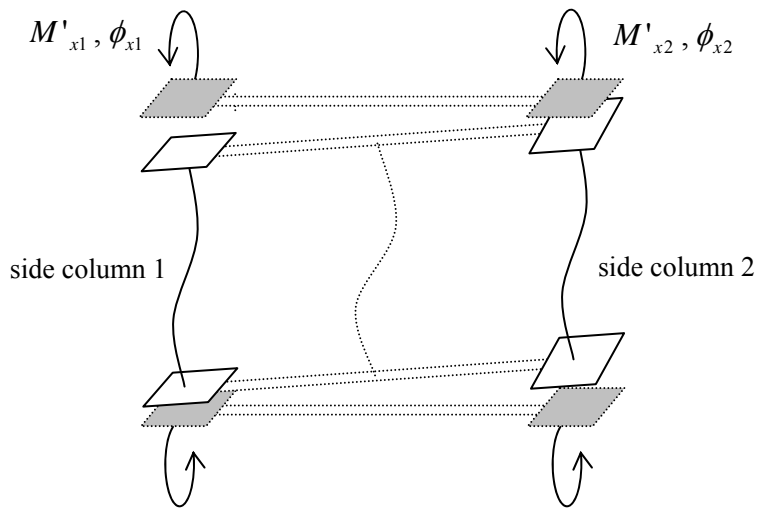

Figure 3-3-4 Equilibrium condition in the out of wall direction

In the out of wall direction, we establish the equilibrium condition for each side column independently. The equilibrium condition for the side column 1 is,

$$\begin{aligned}
M'_{x1} &= -\sum_i^{N1} k_i \varepsilon_i y_i \\
&= -\sum_i^{N1} k_i (\varepsilon_{zc} - y_i \phi_{x1} + x_i \phi_{yc}) y_i \\
&= \left[-\sum_i^{N1} k_i x_i y_i \quad \sum_i^{N1} k_i y_i^2 \quad 0 \quad -\sum_i^{N1} k_i y_i \right] \begin{Bmatrix} \phi_{yc} \\ \phi_{x1} \\ \phi_{x2} \\ \varepsilon_{zc} \end{Bmatrix}
\end{aligned} \tag{3-3-7}$$

Also, for the side column 2,

$$\begin{aligned}
M'_{x2} &= -\sum_i^{N2} k_i \varepsilon_i y_i \\
&= -\sum_i^{N2} k_i (\varepsilon_{zc} - y_i \phi_{x1} + x_i \phi_{yc}) y_i \\
&= \left[-\sum_i^{N2} k_i x_i y_i \quad 0 \quad \sum_i^{N2} k_i y_i^2 \quad -\sum_i^{N2} k_i y_i \right] \begin{Bmatrix} \phi_{yc} \\ \phi_{x1} \\ \phi_{x2} \\ \varepsilon_{zc} \end{Bmatrix}
\end{aligned} \tag{3-3-8}$$

In a matrix form

$$\begin{Bmatrix} M'_{yc} \\ M'_{x1} \\ M'_{x2} \\ N'_{zc} \end{Bmatrix} = \begin{bmatrix} \sum_i^{Nc+N1+N2} k_i x_i^2 & -\sum_i^{N1} k_i x_i y_i & -\sum_i^{N2} k_i x_i y_i & \sum_i^{Nc+N1+N2} k_i x_i \\ -\sum_i^{N1} k_i x_i y_i & \sum_i^{N1} k_i y_i^2 & 0 & -\sum_i^{N1} k_i y_i \\ -\sum_i^{N2} k_i x_i y_i & 0 & \sum_i^{N2} k_i y_i^2 & -\sum_i^{N2} k_i y_i \\ \sum_i^{Nc+N1+N2} k_i x_i & -\sum_i^{N1} k_i y_i & -\sum_i^{N2} k_i y_i & \sum_i^{Nc+N1+N2} k_i \end{bmatrix} \begin{Bmatrix} \phi_{yc} \\ \phi_{x1} \\ \phi_{x2} \\ \varepsilon_{zc} \end{Bmatrix} = [k_p] \begin{Bmatrix} \phi_{yc} \\ \phi_{x1} \\ \phi_{x2} \\ \varepsilon_{zc} \end{Bmatrix} \tag{3-3-9}$$

Therefore

$$\begin{Bmatrix} \phi_{yc} \\ \phi_{x1} \\ \phi_{x2} \\ \varepsilon_{zc} \end{Bmatrix} = [k_p]^{-1} \begin{Bmatrix} M'_{yc} \\ M'_{x1} \\ M'_{x2} \\ N'_{zc} \end{Bmatrix} = [f_p] \begin{Bmatrix} M'_{yc} \\ M'_{x1} \\ M'_{x2} \\ N'_{zc} \end{Bmatrix} \tag{3-3-10}$$

For both ends

$$\begin{Bmatrix} \phi_{yAc} \\ \phi_{xA1} \\ \phi_{xA2} \\ \varepsilon_{zAc} \\ \phi_{yBc} \\ \phi_{xB1} \\ \phi_{xB2} \\ \varepsilon_{zBc} \end{Bmatrix} = \begin{bmatrix} [f_{pA}] & 0 \\ 0 & [f_{pB}] \end{bmatrix} \begin{Bmatrix} M'_{yAc} \\ M'_{xA1} \\ M'_{xA2} \\ N'_{zAc} \\ M'_{yBc} \\ M'_{xB1} \\ M'_{xB2} \\ N'_{zBc} \end{Bmatrix} \quad (3-3-11)$$

For the out of wall direction, each side columns behave independently in the same way as the column element. Therefore, we discuss here only the hysteresis model in the wall panel direction. Hysteresis model of nonlinear bending spring is defined as the moment-rotation relationship under the symmetry loading in Figure 3-3-5. The initial stiffness of the nonlinear spring is supposed to be infinite, however, in numerical calculation, a large enough value is used for the stiffness.

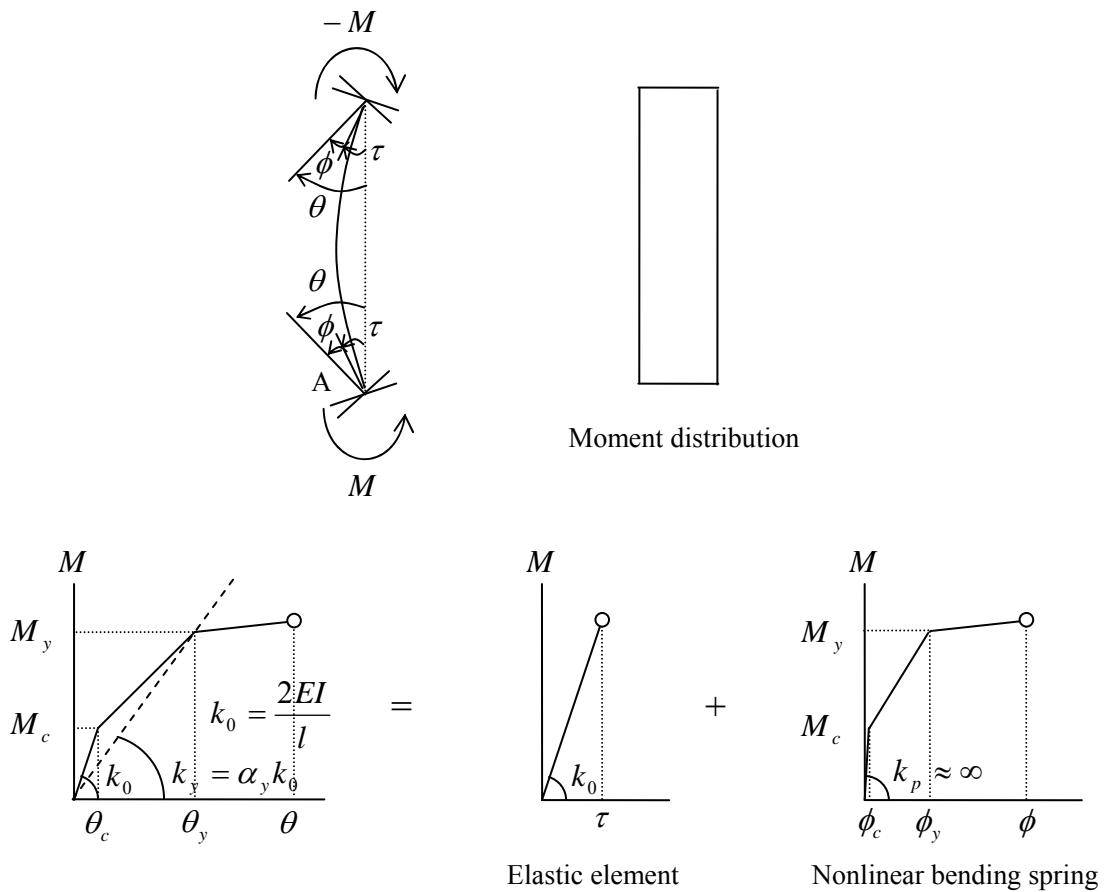

Figure 3-3-5 Moment – rotation relationship at bending spring

The yield moment, M_y is obtained from the equilibrium condition in Figure 3-3-6 as,

$$M_y = a_s \sigma_y l_w + 0.5 a_w \sigma_{wy} l_w + 0.5 N l_w \quad (3-3-12)$$

where,

- a_s : Total area of rebar in the side column
- σ_y : Strength of rebar in the side column
- a_w : Total area of vertical rebar in the wall panel
- σ_{wy} : Strength of rebar in the wall panel
- N : Axial load from the dead load

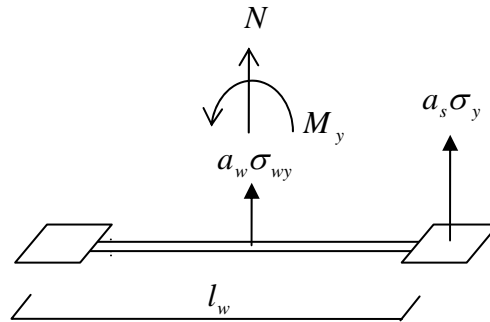

Figure 3-3-6 Equilibrium condition under yielding moment

The crack moment, M_c is assumed to be,

$$M_c = 0.3 M_y \quad (3-3-13)$$

The tangential stiffness at the yield point, k_y , is obtained from the following equation,:

$$k_y = 0.2 K_0 \quad (3-3-14)$$

The yield rotation of the nonlinear bending beam, ϕ_y , is then obtained from,

$$\phi_y = \left(\frac{1}{\alpha_y} - 1 \right) \frac{M_y}{K_0} \quad (3-3-15)$$

where, the stiffness degradation factor, α_y , is assumed as,

$$\alpha_y = 0.02 \quad (3-3-16)$$

c) Nonlinear vertical springs

The nonlinear bending spring is constructed from the nonlinear vertical springs arranged in the member section as shown in Figure 3-3-6. This model is based on the concept of “Multi-spring model” and modified for the wall element by Saito et.al. The vertical springs in the side columns are determined independently in the same way as the Multi-spring models of columns. The wall panel section is divided in 5 areas, and a steel springs and a concrete spring are arranged at the center of each area.

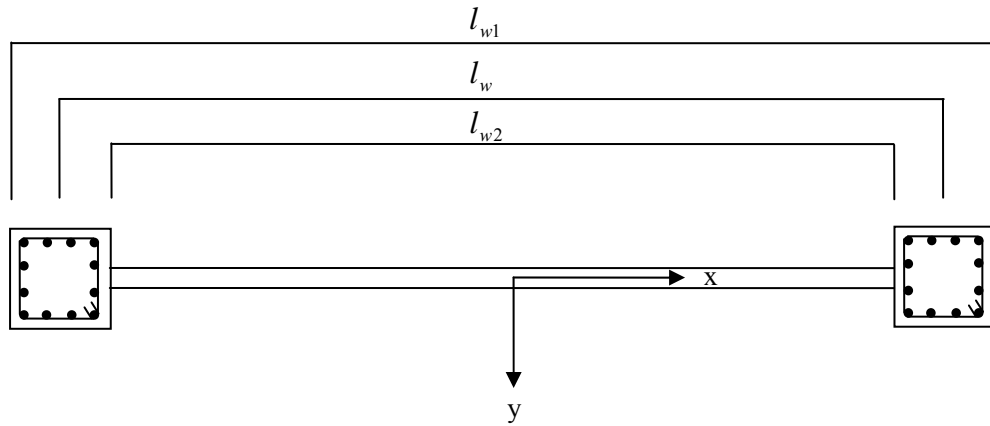

(a) Original column section

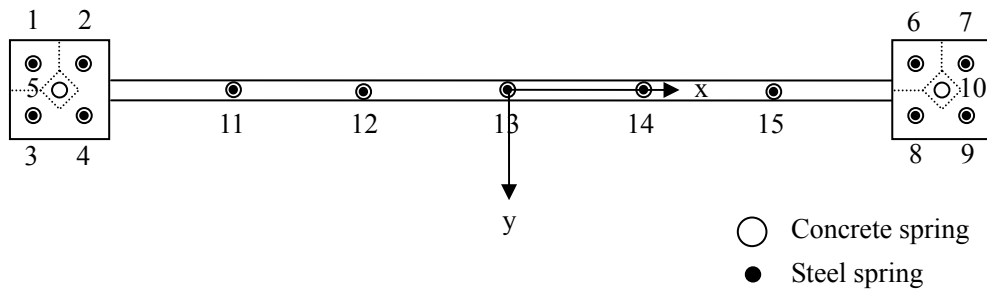

(b) Multi-spring model

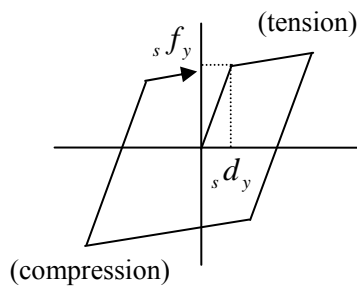

(c) Hysteresis of steel spring

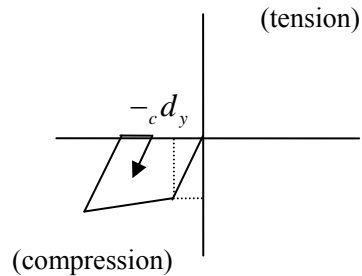

(d) Hysteresis of concrete spring

Figure 3-3-7 Nonlinear vertical springs

Strength of steel spring in wall panel

The strength of the steel spring in the wall panel is one-fifth of total strength of rebars in the section,

$${}_s f_y = \frac{a_w \sigma_{wy}}{5} \quad (3-3-17)$$

where,

- a_w : Total area of vertical rebar in the wall panel
 σ_{wy} : Strength of rebar in the wall panel

Strength of concrete spring in wall panel

The strength of the concrete spring in the wall panel is one-fifth of total strength of concrete in the section,

$${}_c f_y = \frac{0.85 A_p \sigma_B}{5} \quad (3-3-18)$$

where,

- A_p : Total area of wall panel section
 σ_B : Compression strength of concrete

Yield displacement of vertical spring in wall panel

The yield displacements of steel and concrete springs in the wall panel are assumed to be the same as those of the springs in the side columns.

d) Nonlinear shear spring

There are three nonlinear shear springs in x direction in wall panel and y direction in side columns. Hysteresis model of the nonlinear shear springs is the same as that in the beam element in Figure 3-1-4.

Yield shear force

The yield shear force, Q_y is calculated as,

$$Q_y = \left\{ \frac{0.053 p_t^{0.23} (\sigma_B + 18)}{M/(QD) + 0.12} + 0.85 \sqrt{p_w \cdot \sigma_{wy}} + 0.1 \sigma_0 \right\} b \cdot j \quad (3-3-19)$$

where,

- p_t : Tensile reinforcement ratio
 σ_B : Compression strength of concrete
 $M/(QD)$: \approx Shear span-to-depth ratio ($=l/(2D)$)
 p_w : Shear reinforcement ratio
 σ_{wy} : Strength of shear reinforcement
 σ_0 : Axial stress of the column
 j : Distance between the centers of stress in the section ($= (7/8)d$).

Crack shear force

The crack shear force is, Q_c , is assumed as,

$$Q_c = \frac{Q_y}{3} \tag{3-3-20}$$

Ultimate shear force

The crack shear force is, Q_u , is assumed as,

$$Q_u = Q_c \tag{3-3-21}$$

Crack shear deformation

The crack shear deformation is obtained as,

$$\gamma_c = \frac{Q_c}{GA} \tag{3-3-22}$$

Yield shear displacement

The yield shear deformation is assumed as,

$$\gamma_y = \frac{1}{250} \tag{3-3-23}$$

Ultimate shear displacement

The ultimate shear deformation is assumed as,

$$\gamma_u = \frac{1}{100} \tag{3-3-24}$$

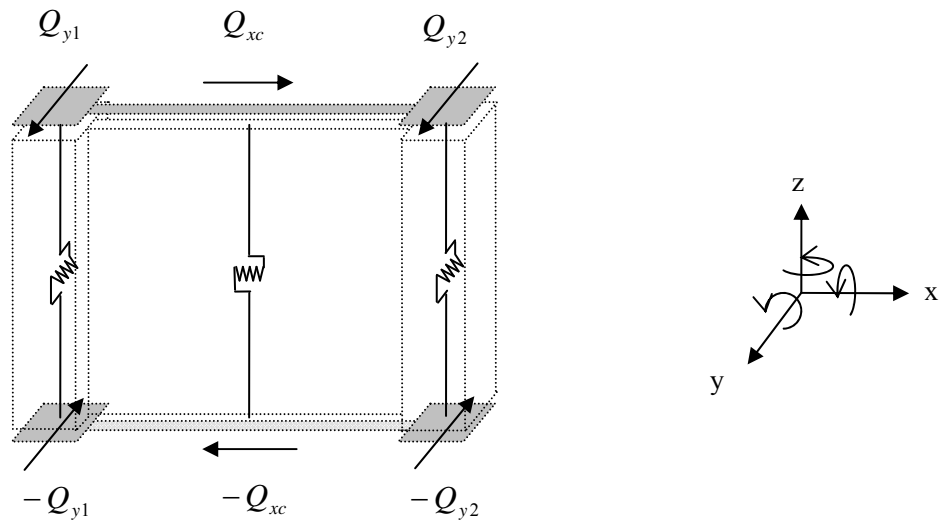

Figure 3-3-8 Nonlinear shear springs in the wall

e) Modification of initial stiffness of nonlinear springs

The same modification can be done for the nonlinear springs of wall element as described for those of beam and column elements by reducing the initial stiffness of the nonlinear spring and increasing the stiffness of the elastic element as shown in the following figure:

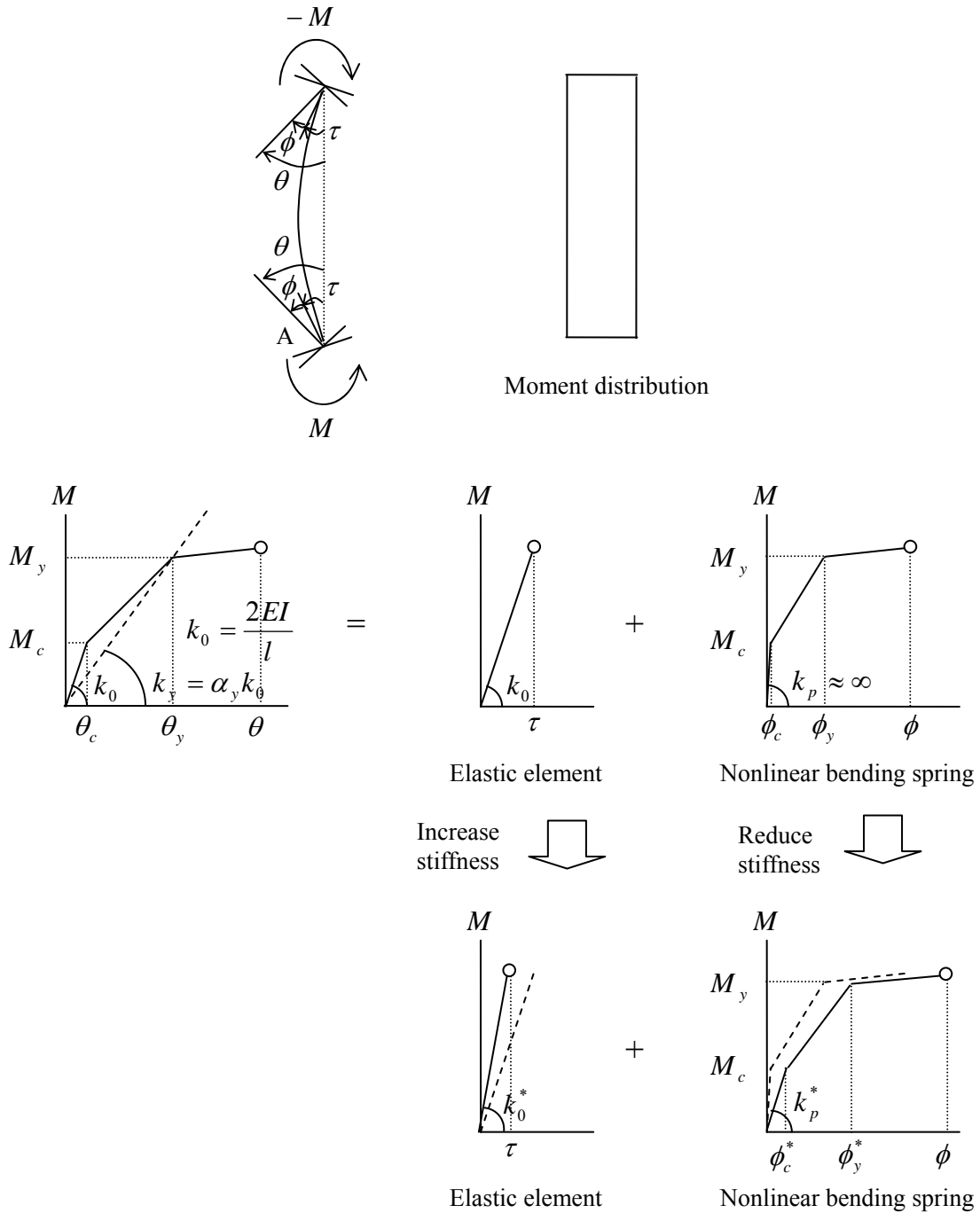

Figure 3-3-9 Modification of moment – rotation relationship

Introducing the concept of “plastic zones”, the initial stiffness of the i-th multi-spring can be expressed as,

$$k_0^i = \frac{E_i A_i}{p_z} \quad (3-3-25)$$

where E_i : the material young’s modulus, A_i : the spring governed area, and p_z : the length of assumed plastic zone. When $p_z \rightarrow 0$, it represents the infinite stiffness for rigid condition.

In the same manner of beam and column elements, introducing the flexibility reduction factors, $\gamma_0 (< 0)$, $\gamma_1 (< 0)$, $\gamma_2 (< 0)$, the flexibility matrix of the elastic element is,

$$[f_w] = \begin{bmatrix} \gamma_1 \frac{l'}{3EI_c} & -\frac{l'}{6EI_c} & & & & & & & \\ & \gamma_2 \frac{l'}{3EI_c} & & & & & & & \\ & & \gamma_1 \frac{l'}{3EI_1} & -\frac{l'}{6EI_1} & & & & & \\ & & & \gamma_2 \frac{l'}{3EI_1} & & & & & \\ & & & & \gamma_1 \frac{l'}{3EI_2} & -\frac{l'}{6EI_2} & & & \\ & & & & & \gamma_2 \frac{l'}{3EI_2} & & & \\ & & & & & & \gamma_0 \frac{l'}{EA_c} & & \\ & & & & & & & & \end{bmatrix} \quad (3-3-26)$$

sym.

Also, adopting $p_z = \frac{l'}{10}$ as discussed for beam and column elements, the reduction factors will be:

$$\gamma_1 = \gamma_2 = 0.7, \quad \gamma_0 = 0.8 \quad (3-3-27)$$

3.4 Wall Panel

a) Section properties

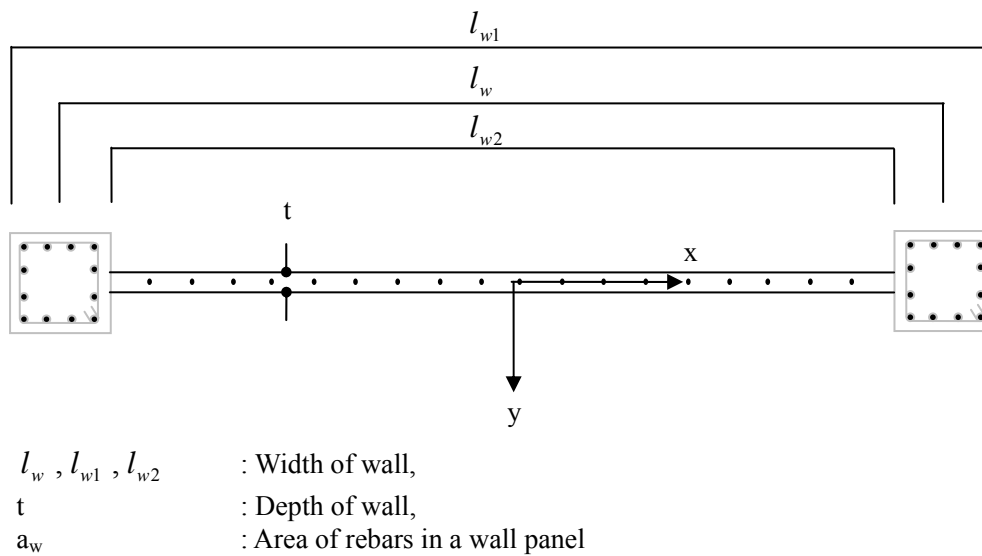

Figure 3-4-1 Wall Section

Area of section to calculate axial deformation

$$A_N = t l_{w2} + (n_E - 1)(a_w) \quad (3-4-1)$$

where,

$$n_E = E_s / E_c \quad : \text{Ratio of Young's modulus between steel } (E_s) \text{ and concrete } (E_c)$$

Area of section to calculate shear deformation

$$A_S = t l_{w2} / \kappa, \quad \kappa = 1.2 \quad (3-4-2)$$

where,

$$A_{S,C1}, A_{S,C2} \quad : \text{Area of section of side columns for shear deformation}$$

Moment of inertia around the center of the section

$$I_y = \frac{l_{w2} t^3}{12} \quad (3-4-3)$$

b) Nonlinear bending spring

To consider nonlinear interaction among $M_x - M_y - N_z$, the nonlinear bending spring at the member end is constructed from the nonlinear vertical springs arranged in the member section as shown in Figure 3-3-2.

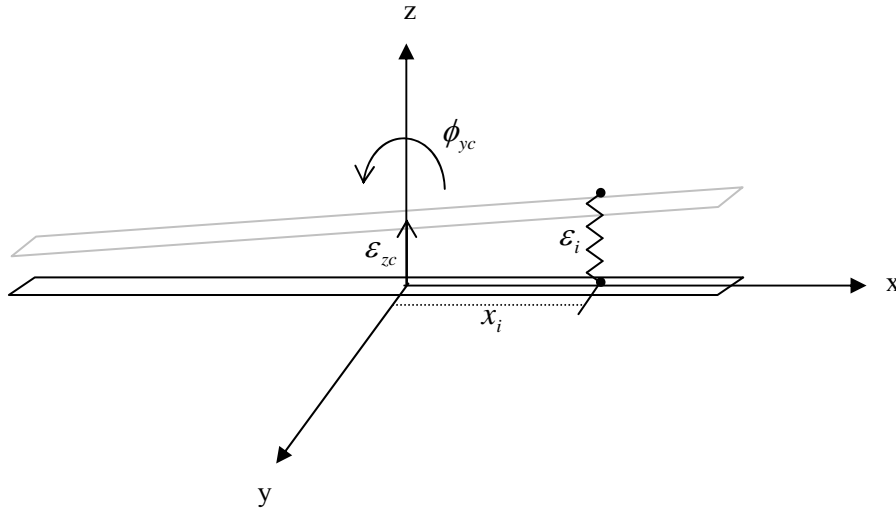

Figure 3-4-2 Nonlinear bending springs

Displacement of the i -th nonlinear axial spring is,

$$\epsilon_i = \epsilon_{zc} + x_i \phi_{yz} \quad (3-4-4)$$

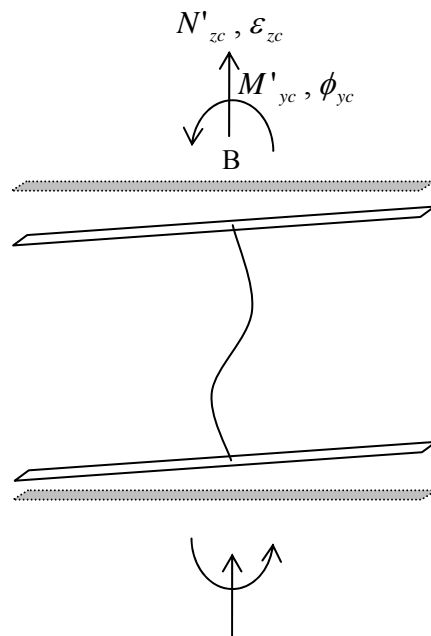

Figure 3-4-3 Equilibrium condition in the wall panel direction

In the wall panel direction, all vertical springs in the nonlinear section are assumed to work against the moment and the axial force. The equilibrium conditions are,

$$M'_{yc} = \sum_i^{Nc} k_i \varepsilon_i x_i = \sum_i^{Nc} k_i (\varepsilon_{zc} + x_i \phi_{yc}) x_i = \begin{bmatrix} \sum_i^{Nc} k_i x_i^2 & \sum_i^{Nc} k_i x_i \end{bmatrix} \begin{Bmatrix} \phi_{yc} \\ \varepsilon_{zc} \end{Bmatrix} \quad (3-4-5)$$

$$N'_{zc} = \sum_i^{Nc} k_i \varepsilon_i = \sum_i^{Nc} k_i (\varepsilon_{zc} + x_i \phi_{yc}) = \begin{bmatrix} \sum_i^{Nc} k_i x_i & \sum_i^{Nc} k_i \end{bmatrix} \begin{Bmatrix} \phi_{yc} \\ \varepsilon_{zc} \end{Bmatrix} \quad (3-4-6)$$

where, Nc , is the number of vertical springs in a wall panel.

In a matrix form

$$\begin{Bmatrix} M'_{yc} \\ N'_{zc} \end{Bmatrix} = \begin{bmatrix} \sum_i^{Nc} k_i x_i^2 & \sum_i^{Nc} k_i x_i \\ \sum_i^{Nc} k_i x_i & \sum_i^{Nc} k_i \end{bmatrix} \begin{Bmatrix} \phi_{yc} \\ \varepsilon_{zc} \end{Bmatrix} = [k_p] \begin{Bmatrix} \phi_{yc} \\ \varepsilon_{zc} \end{Bmatrix} \quad (3-4-7)$$

Therefore

$$\begin{Bmatrix} \phi_{yc} \\ \varepsilon_{zc} \end{Bmatrix} = [k_p]^{-1} \begin{Bmatrix} M'_{yc} \\ N'_{zc} \end{Bmatrix} = [f_p] \begin{Bmatrix} M'_{yc} \\ N'_{zc} \end{Bmatrix} \quad (3-4-8)$$

For both ends

$$\begin{Bmatrix} \phi_{yAc} \\ \varepsilon_{zAc} \\ \phi_{yBc} \\ \varepsilon_{zBc} \end{Bmatrix} = \begin{bmatrix} [f_{pA}] & 0 \\ 0 & [f_{pB}] \end{bmatrix} \begin{Bmatrix} M'_{yAc} \\ N'_{zAc} \\ M'_{yBc} \\ N'_{zBc} \end{Bmatrix} \quad (3-4-9)$$

Hysteresis model of nonlinear bending spring is defined as the moment-rotation relationship under the symmetry loading in Figure 3-4-5. The initial stiffness of the nonlinear spring is supposed to be infinite, however, in numerical calculation, a large enough value is used for the stiffness.

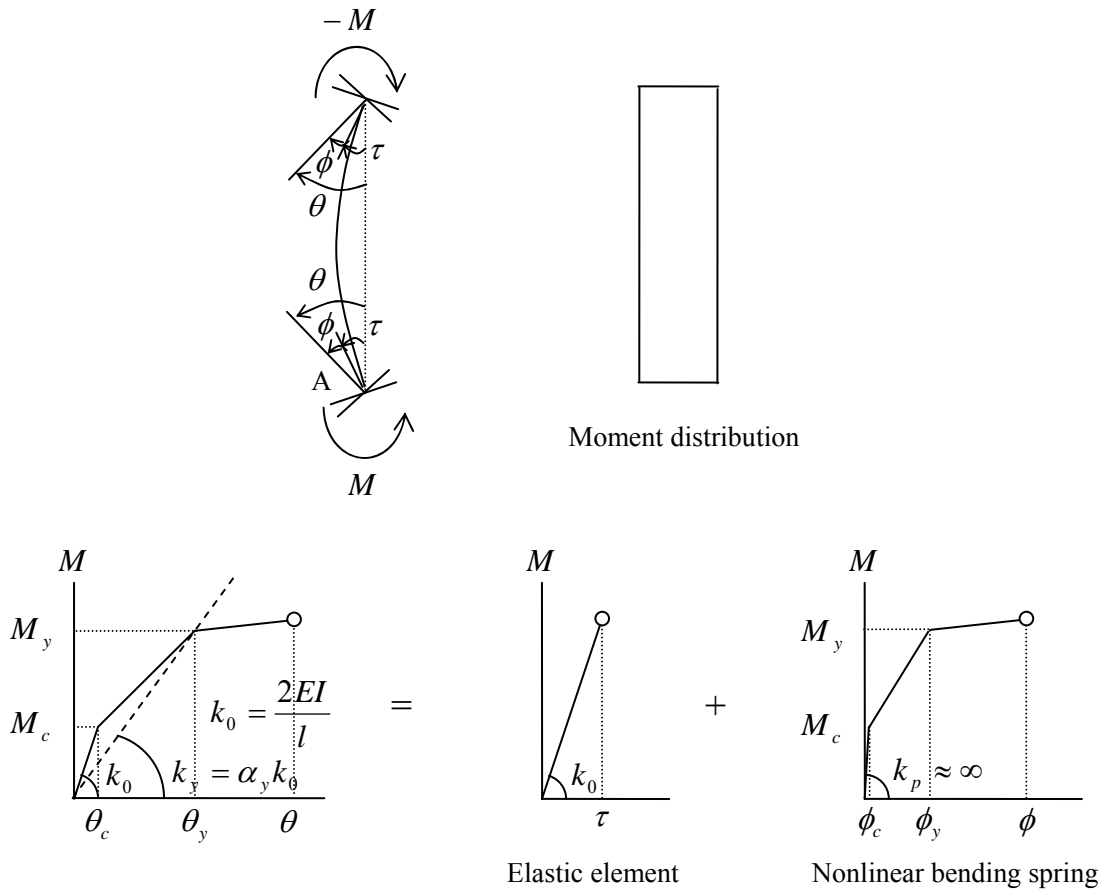

Figure 3-4-5 Moment – rotation relationship at bending spring

The yield moment, M_y is obtained from the equilibrium condition in Figure 3-4-6 as,

$$M_y = 0.5a_w \sigma_{wy} l_w + 0.5Nl_w \quad (3-4-10)$$

where,

- a_s : Total area of rebar in the side column
- a_w : Total area of vertical rebar in the wall panel
- σ_{wy} : Strength of rebar in the wall panel
- N : Axial load from the dead load

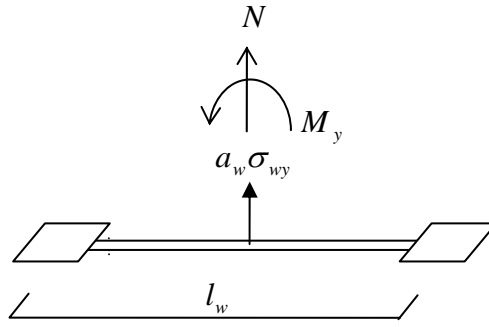

Figure 3-4-6 Equilibrium condition under yielding moment

The crack moment, M_c is assumed to be,

$$M_c = 0.3M_y \quad (3-4-13)$$

The tangential stiffness at the yield point, k_y , is obtained from the following equation,:

$$k_y = 0.2K_0 \quad (3-4-14)$$

The yield rotation of the nonlinear bending beam, ϕ_y , is then obtained from,

$$\phi_y = \left(\frac{1}{\alpha_y} - 1 \right) \frac{M_y}{K_0} \quad (3-4-15)$$

where, the stiffness degradation factor, α_y , is assumed as,

$$\alpha_y = 0.02 \quad (3-4-16)$$

c) Nonlinear vertical springs

The nonlinear bending spring is constructed from the nonlinear vertical springs arranged in the member section as shown in Figure 3-3-6. This model is based on the concept of “Multi-spring model” and modified for the wall element by Saito et.al. The vertical springs in the side columns are determined independently in the same way as the Multi-spring models of columns. The wall panel section is divided in 5 areas, and a steel springs and a concrete spring are arranged at the center of each area.

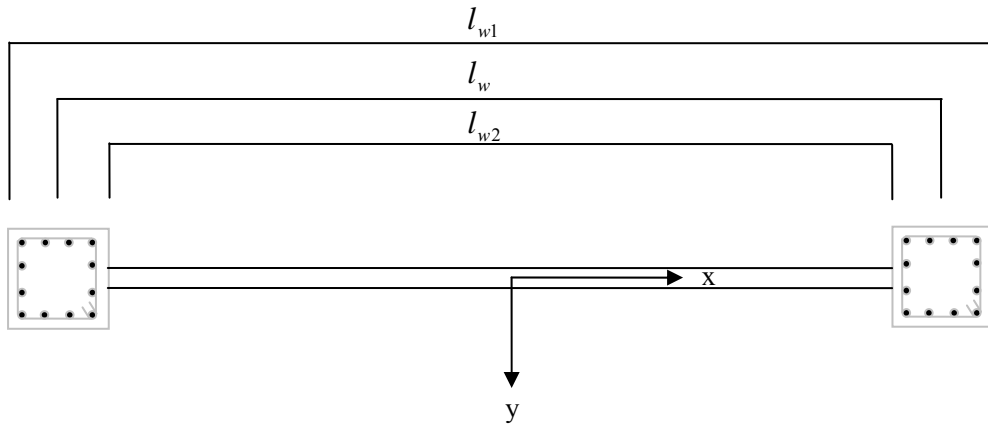

(a) Original column section

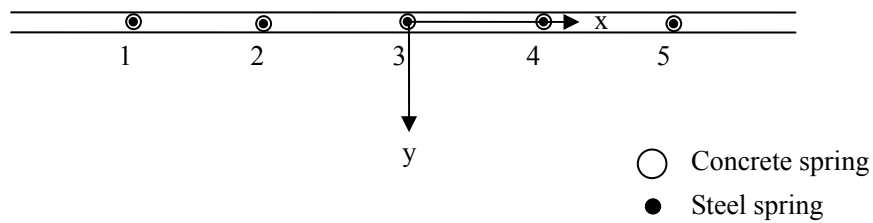

(b) Multi-spring model

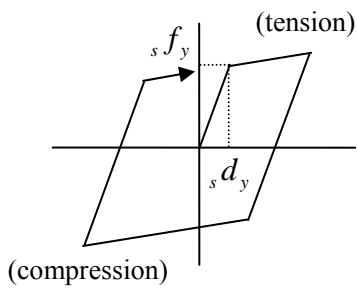

(c) Hysteresis of steel spring

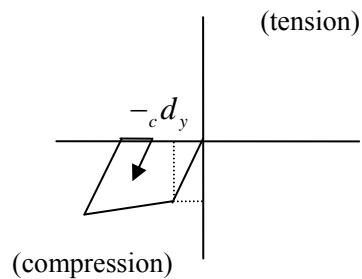

(d) Hysteresis of concrete spring

Figure 3-4-7 Nonlinear vertical springs

Strength of steel spring in wall panel

The strength of the steel spring in the wall panel is one-fifth of total strength of rebars in the section,

$${}_s f_y = \frac{a_w \sigma_{wy}}{5} \quad (3-4-17)$$

where,

- a_w : Total area of vertical rebar in the wall panel
 σ_{wy} : Strength of rebar in the wall panel

Strength of concrete spring in wall panel

The strength of the concrete spring in the wall panel is one-fifth of total strength of concrete in the section,

$${}_c f_y = \frac{0.85 A_p \sigma_B}{5} \quad (3-4-18)$$

where,

- A_p : Total area of wall panel section
 σ_B : Compression strength of concrete

Yield displacement of vertical spring in wall panel

The yield displacements of steel and concrete springs in the wall panel are assumed to be the same as those of the springs in the side columns.

d) Nonlinear shear spring

There is a nonlinear shear spring in x direction in wall panel. Hysteresis model of the nonlinear shear springs is the same as that in the beam element in Figure 3-1-4.

Yield shear force

The yield shear force, Q_y is calculated as,

$$Q_y = \left\{ \frac{0.053 p_t^{0.23} (\sigma_B + 18)}{M/(QD) + 0.12} + 0.85 \sqrt{p_w \cdot \sigma_{wy}} + 0.1 \sigma_0 \right\} b \cdot j \quad (3-3-19)$$

where,

- p_t : Tensile reinforcement ratio
 σ_B : Compression strength of concrete
 $M/(QD)$: \approx Shear span-to-depth ratio ($=l/(2D)$)
 p_w : Shear reinforcement ratio
 σ_{wy} : Strength of shear reinforcement
 σ_0 : Axial stress of the column
 j : Distance between the centers of stress in the section ($= (7/8)d$).

Crack shear force

The crack shear force is, Q_c , is assumed as,

$$Q_c = \frac{Q_y}{3} \quad (3-3-20)$$

Ultimate shear force

The crack shear force is, Q_u , is assumed as,

$$Q_u = Q_c \quad (3-3-21)$$

Crack shear deformation

The crack shear deformation is obtained as,

$$\gamma_c = \frac{Q_c}{GA} \quad (3-3-22)$$

Yield shear displacement

The yield shear deformation is assumed as,

$$\gamma_y = \frac{1}{250} \quad (3-3-23)$$

Ultimate shear displacement

The ultimate shear deformation is assumed as,

$$\gamma_u = \frac{1}{100} \quad (3-3-24)$$

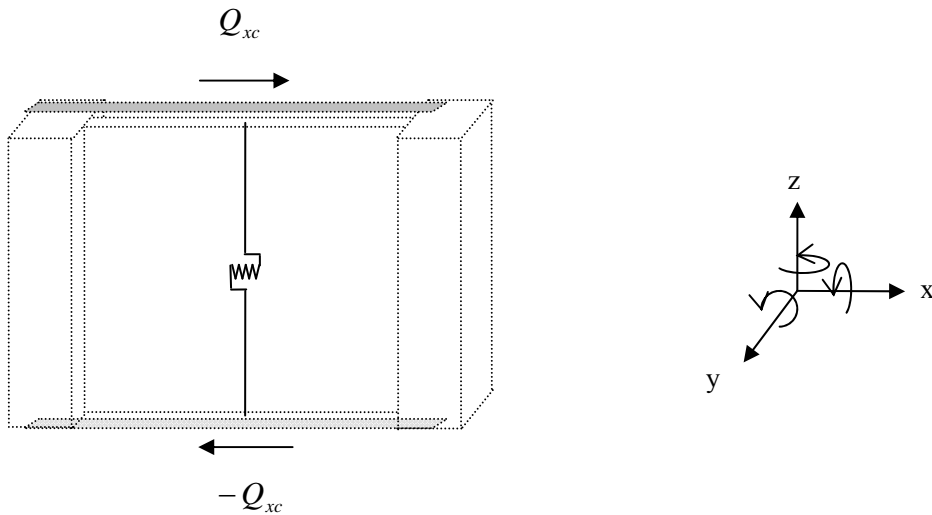

Figure 3-4-8 Nonlinear shear springs in the wall

e) Modification of initial stiffness of nonlinear springs

The same modification can be done for the nonlinear springs of wall element as described for those of beam and column elements by reducing the initial stiffness of the nonlinear spring and increasing the stiffness of the elastic element as shown in the following figure:

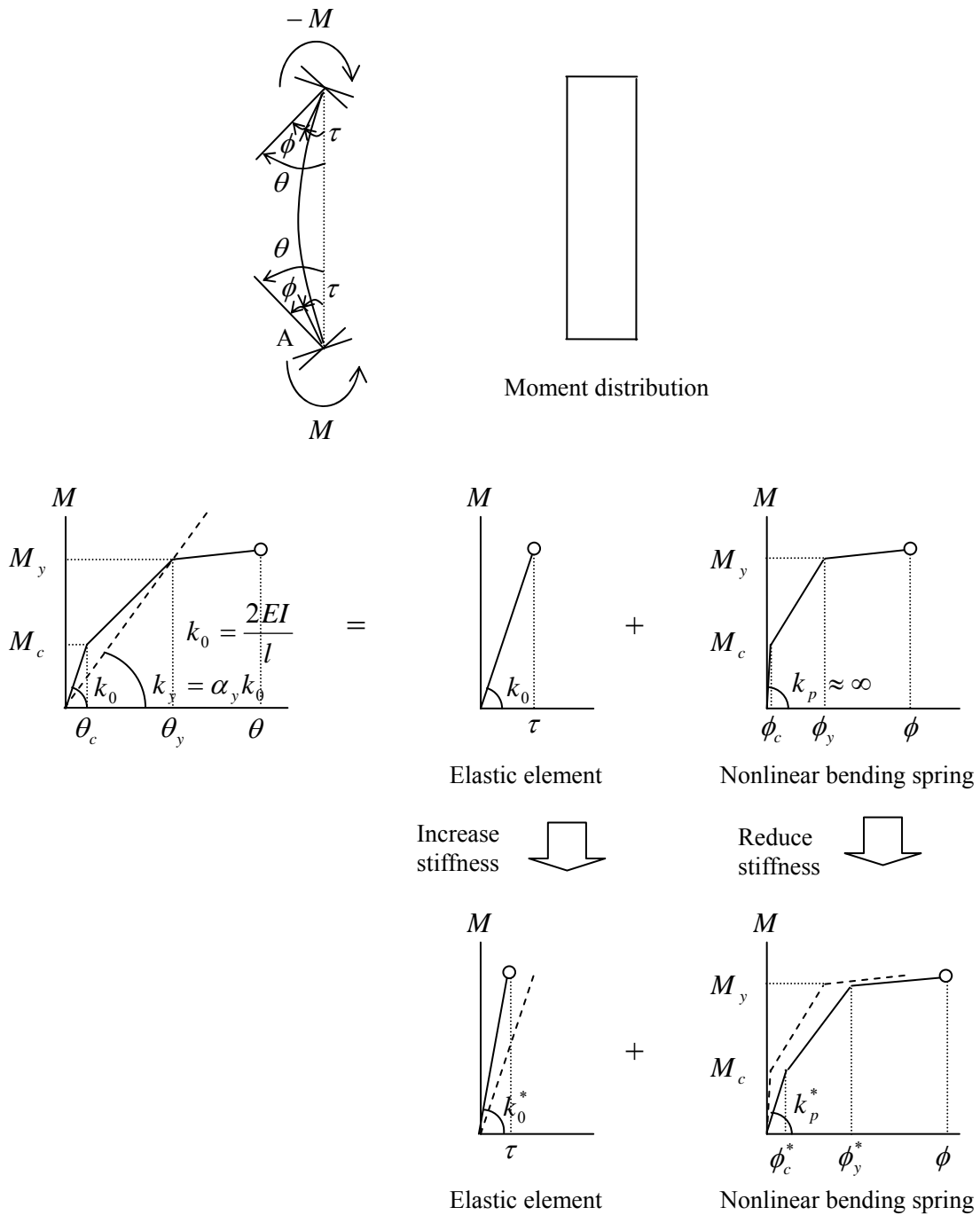

Figure 3-3-9 Modification of moment – rotation relationship

Introducing the concept of “plastic zones”, the initial stiffness of the i -th multi-spring can be expressed as,

$$k_0^i = \frac{E_i A_i}{p_z} \quad (3-4-25)$$

where E_i : the material young’s modulus, A_i : the spring governed area, and p_z : the length of assumed plastic zone. When $p_z \rightarrow 0$, it represents the infinite stiffness for rigid condition.

In the same manner of beam and column elements, introducing the flexibility reduction factors, $\gamma_0 (< 0)$, $\gamma_1 (< 0)$, $\gamma_2 (< 0)$, the flexibility matrix of the elastic element is,

$$[f_{WP}] = \begin{bmatrix} \gamma_1 \frac{l'}{3EI_c} & -\frac{l'}{6EI_c} & & \\ & \gamma_2 \frac{l'}{3EI_c} & & \\ \text{sym.} & & & \gamma_0 \frac{l'}{EA_c} \end{bmatrix} \quad (3-4-26)$$

Also, adopting $p_z = \frac{l'}{10}$ as discussed for beam and column elements, the reduction factors will be:

$$\gamma_1 = \gamma_2 = 0.7, \quad \gamma_0 = 0.8 \quad (3-4-27)$$

3.5 External Spring

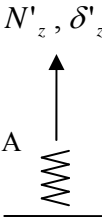

Figure 3-5-1 Element model for external spring

a) Nonlinear vertical spring

In STERA_3D, the external spring is attached at the base of the building to express the stiffness and strength of the foundation of the building. In such a case, hysteresis model of the nonlinear vertical spring is defined as the axial force – displacement relationship as shown in Figure 3-5-2; where, bilinear skeleton is defined only in compression side, and the spring has zero stiffness in the tension side assuming that the building detaches from the ground.

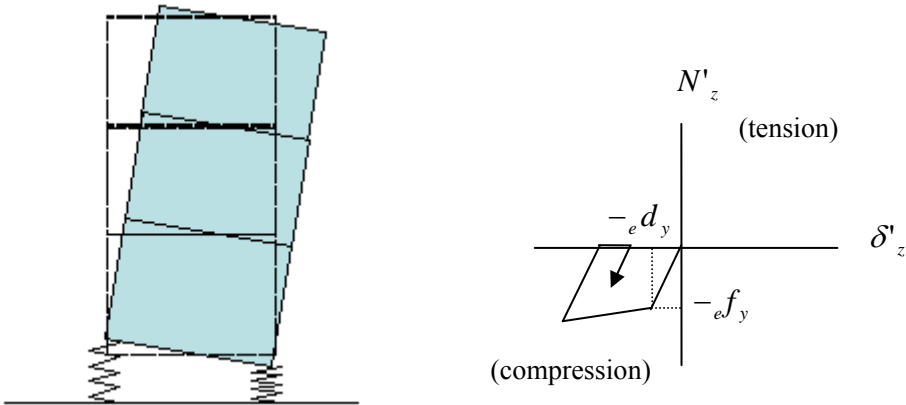

Figure 3-5-2 Hysteresis model of the external spring

Initial stiffness

The initial stiffness of the vertical stiffness can be obtained from the following equation:

$$k_e = a_F A_F \tag{3-5-1}$$

where,

- a_F : Dynamic ground coefficient (kN/m²)
- A_F : Area of foundation under column or wall element (m²)

3.6 Base Isolation

The element model of base isolation consists of shear springs arranged in x-y plane changing its direction with equal angle interval as shown in Figure 3-5-1. This model is called MSS (Multi-Shear Spring) model developed by Wada et al.

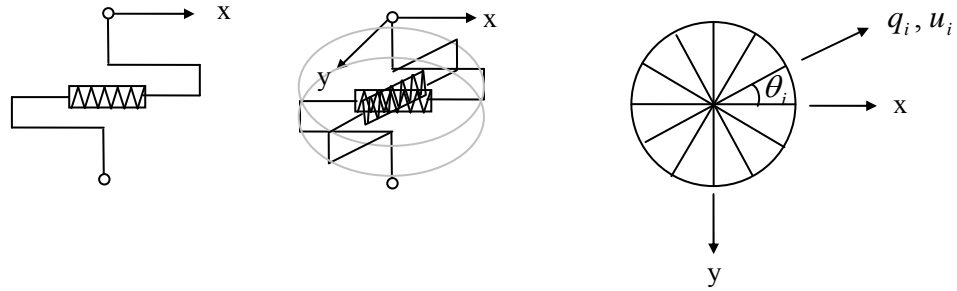

Figure 3-6-1 Element model of base isolation

a) Nonlinear shear spring

The hysteresis model of each nonlinear shear spring is defined as a bi-linear model as shown in Figure 3-6-2. The force and displacement vectors of i-th shear spring are expressed as,

$$\begin{Bmatrix} q_{i,x} \\ q_{i,y} \end{Bmatrix} = \begin{bmatrix} \cos \theta_i \\ \sin \theta_i \end{bmatrix} q_i \quad (3-6-1)$$

$$u_i = \begin{bmatrix} \cos \theta_i & \sin \theta_i \end{bmatrix} \begin{Bmatrix} u_x \\ u_y \end{Bmatrix} \quad (3-6-2)$$

From the relationship, $q_i = k_i u_i$, the constitutive equation of i-th shear spring is,

$$\begin{Bmatrix} q_{i,x} \\ q_{i,y} \end{Bmatrix} = k_i \begin{bmatrix} \cos \theta_i \\ \sin \theta_i \end{bmatrix} \begin{bmatrix} \cos \theta_i & \sin \theta_i \end{bmatrix} \begin{Bmatrix} u_x \\ u_y \end{Bmatrix} = \begin{bmatrix} \cos^2 \theta_i & \cos \theta_i \sin \theta_i \\ \cos \theta_i \sin \theta_i & \sin^2 \theta_i \end{bmatrix} \begin{Bmatrix} u_x \\ u_y \end{Bmatrix} \quad (3-6-3)$$

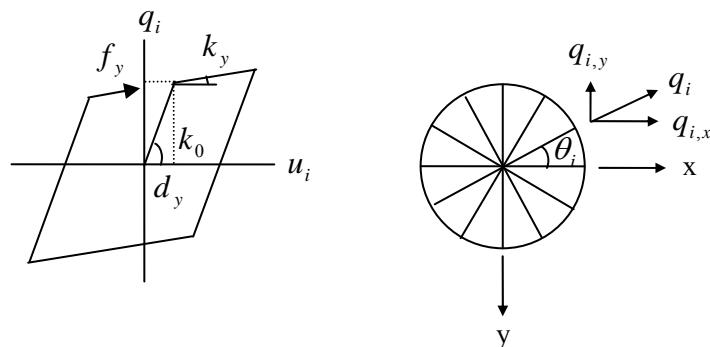

Figure 3-6-2 Hysteresis model of the shear spring

From the sum of all nonlinear shear springs in the element, the constitutive equation of the base isolation element is,

$$\begin{Bmatrix} Q_x \\ Q_y \end{Bmatrix} = \left(\sum_{i=1}^N k_i \begin{bmatrix} \cos^2 \theta_i & \cos \theta_i \sin \theta_i \\ \cos \theta_i \sin \theta_i & \sin^2 \theta_i \end{bmatrix} \right) \begin{Bmatrix} u_x \\ u_y \end{Bmatrix} \quad (3-6-4)$$

where, N is the number of shear springs in an element. In STERA_3D, $N=6$ is selected.

First and second stiffness

We assume that all nonlinear shear springs in an element have the same stiffness and strength. The initial stiffness of the base isolation element, K_0 , is obtained from Equation (3-6-4) by substituting $u_x = 1, u_y = 0$.

$$K_0 = \left(\sum_{i=1}^N \cos^2 \theta_i \right) k_0 \quad (3-6-5)$$

Therefore, the initial stiffness of each shear spring is,

$$k_0 = \frac{K_0}{\sum_{i=1}^N \cos^2 \theta_i} \quad (3-6-6)$$

The same relationship is established for the second stiffness after yielding,

$$k_y = \frac{K_y}{\sum_{i=1}^N \cos^2 \theta_i} \quad (3-6-7)$$

where, K_y and k_y are the second stiffness after yielding for the base isolation element and the nonlinear shear spring, respectively.

Yield shear force

The yield shear force of the base isolation element, Q_y , is obtained assuming that all the nonlinear shear springs reach their yielding points except the spring perpendicular to the loading direction, and the increase of the force after yielding is negligible (Figure 3-6-3). That is,

$$Q_y = \left(\sum_{i=1}^N |\cos \theta_i| \right) f_y \quad (3-6-8)$$

Therefore, the yield shear force of each shear spring is,

$$f_y = \frac{Q_y}{\sum_{i=1}^N |\cos \theta_i|} \quad (3-6-9)$$

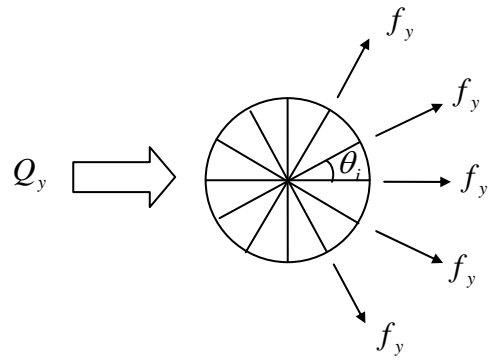

Figure 3-6-3 Assumption of yield shear force

3.7 Masonry Wall

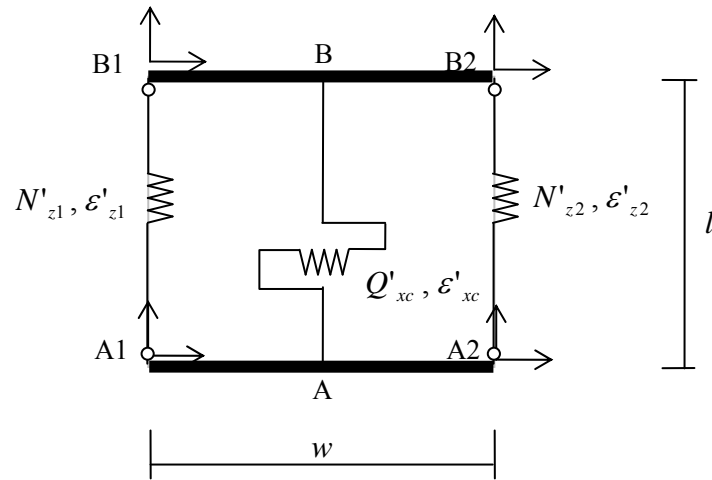

Figure 3-7-1 Element model for masonry wall

a) Nonlinear shear spring

Hysteresis model of the nonlinear shear spring is defined as the poly-linear slip model as shown in Figure 3-7-2.

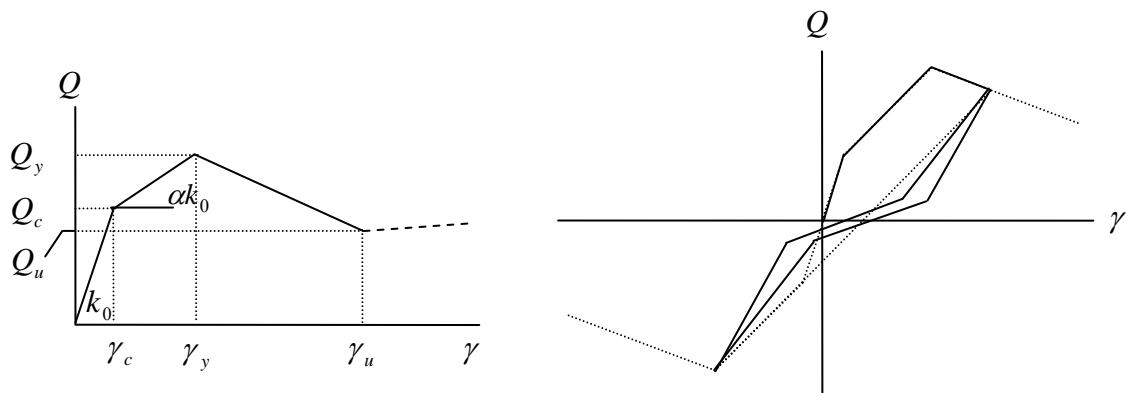

Figure 3-7-2 Hysteresis model of the nonlinear shear spring

The characteristic values, Q_c , Q_y , Q_u are obtained based on the formulation described in the reference (Paulay and Priestley, 1992).

The procedure to obtain the shear strength is shown below:

(1) Compression strength of masonry prism

The compression strength of the masonry prism (f'_m) is determined by the following equation (Paulay and Priestley, 1992),

$$f'_m = \frac{f'_{cb}(f'_{tb} + \alpha f'_j)}{U_u(f'_{tb} + \alpha f'_{cb})} \quad (3-7-1)$$

$$\alpha = \frac{j}{4.1h_b} \quad (3-7-2)$$

where,

f'_{cb}	:	Compressive strength of the brick
f'_{tb}	:	Tensile strength of the brick ($= 0.1 f'_{cb}$)
f'_j	:	Compressive strength of the mortar
j	:	Mortar joint thickness
h_b	:	Height of masonry unit
U_u	:	Stress non-uniformity coefficient ($=1.5$)

(2) Shear strength by sliding shear failure

There are two types of shear failure; one is sliding shear failure which is determined by,

$$V_f = \frac{\tau_0 t l_m}{(1 - \mu \tan \theta)} \quad (3-7-3)$$

where,

τ_0	:	Cohesive capacity of the mortar beds ($=0.04 f'_m$) (Paulay and Priestly, 1992)
μ	:	Sliding friction coefficient along the bed joint $\mu = 0.654 + 0.000515 f'_j$ (Chen et.al, 2003)
θ	:	Angle subtended by diagonal strut to horizontal plane

(3) Shear strength by diagonal compression failure

$$V_c = Z t f'_m \cos \theta \quad (3-7-4)$$

where,

Z	:	Equivalent strut width $Z = 0.25 d_m$, d_m is diagonal length (Paulay and Priestley, 1992)
t	:	Thickness of masonry wall

(4) Characteristic values of nonlinear skeleton

The shear resistance, Q_y , is calculated to be the minimum value between the shear strength by sliding shear failure, V_f , and the shear strength of diagonal compression failure, V_c , that is,

$$Q_y = \min(V_f, V_c) \quad (3-7-5)$$

The shear displacement at the maximum resistance, γ_y , is obtained as (Madan et al., 1997),

$$\gamma_y = \frac{\varepsilon'_m d_m}{\cos \theta} \quad (3-7-6)$$

where,

$$\varepsilon'_m \quad : \quad \text{Compression strain at the maximum compression stress} \\ (\varepsilon'_m = 0.0018, \text{ Hossein and Kabeyasawa, 2004})$$

Initial elastic stiffness is assumed as (Madan et al., 1997)

$$k_0 = 2Q_y / \gamma_y \quad (3-7-7)$$

From Figure 3-7-2, the shear resistance at crack, Q_c , is obtained as,

$$Q_c = \frac{Q_y - \alpha k_0 \gamma_y}{1 - \alpha} \quad (3-7-8)$$

where, α is the stiffness ratio of the second stiffness and assumed to be 0.2.

Shear displacement at crack is then obtained as,

$$\gamma_c = Q_c / k_0 \quad (3-7-9)$$

Shear resistance and displacement at the ultimate stage are assumed as (Hossein & Kabeyasawa, 2004)

$$Q_u = 0.3Q_y \quad (3-7-10)$$

$$\gamma_u = 3.5(0.01h_m - \gamma_y) \quad (3-7-11)$$

where, h_m is the height of masonry wall.

References:

- 1) T. Pauley, M.J.N. Priestley, 1992, Seismic Design of Reinforced Concrete and Masonry building, JOHN WILEY & SONS, INC.
- 2) Hossein Mostafaei, Toshimi Kabeyasawa, 2004, Effect of Infill Walls on the Seismic Response of Reinforced Concrete Buildings Subjected to the 2003 Bam Earthquake Strong Motion : A Case Study of Bam Telephone Centre, Bulletin Earthquake Research Institute, The university of Tokyo
- 3) A. Madan, A.M. Reinhorn, J. B. Mandar, R.E. Valles, 1997, Modeling of Masonry Infill Panels for Structural Analysis, Journal of Structural Division, ASCE, Vol.114, No.8, pp.1827-1849

b) Vertical springs

For the moment, the vertical springs of the element model in Figure 3-7-1 are assumed to be elastic springs.

$$N'_{z1} = k_z \varepsilon'_{z1}, \quad N'_{z2} = k_z \varepsilon'_{z2} \quad (3-7-12)$$

$$k_z = E_m (t l_w) / 2 \quad (3-7-13)$$

where,

E_m	:	Modulus of elasticity of masonry prism (=550 f'_m , FEMA 356, 2000)
t	:	Thickness of masonry wall
l_w	:	Width of masonry wall

3.8 Passive Damper

a) Hysteresis damper

Hysteresis damper is modeled as a shear spring as shown in Figure 3-8-1.

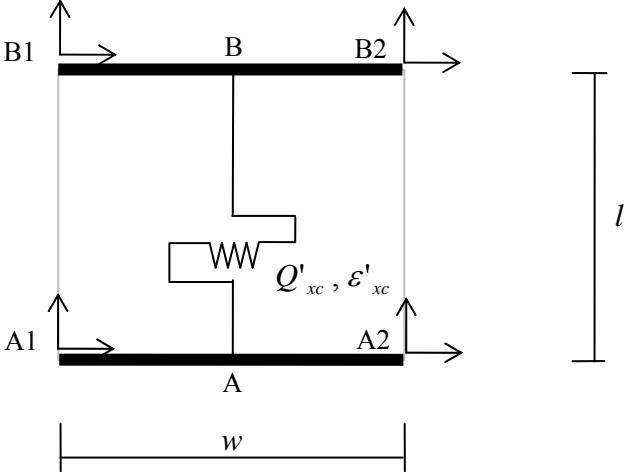

Figure 3-8-1 Element model for passive damper

Three types of hysteresis model are prepared for the force-deformation relationship of the spring.

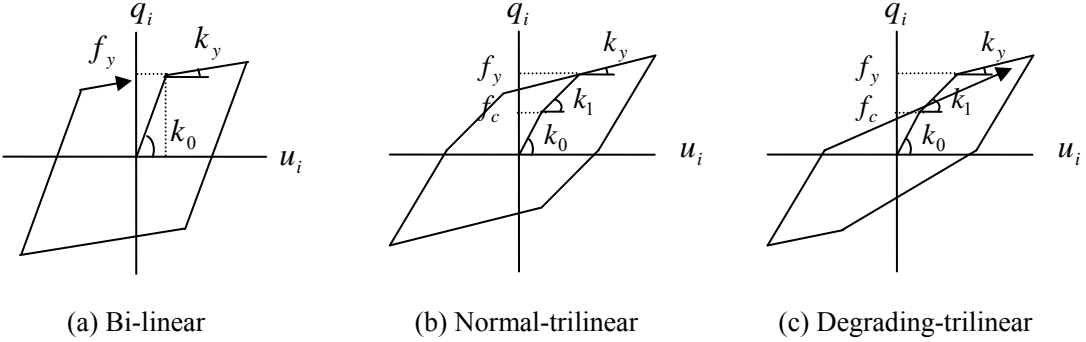

Figure 3-8-2 Hysteresis model of the shear spring

b) Viscous damper

Viscous damper is modeled as a shear spring as shown in Figure 3-8-3.

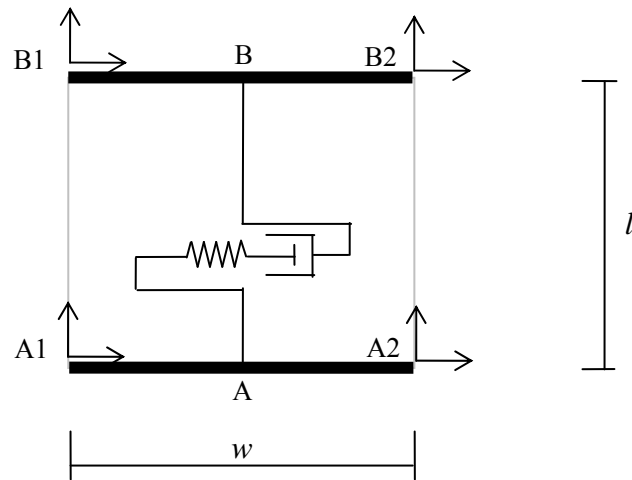

Figure 3-8-3 Element model for passive damper

(1) Algorithm for oil damper devise

Figure 3-8-4 shows the Maxwell model with an elastic spring with stiffness, K_d , and a dashpot with damping coefficient, C .

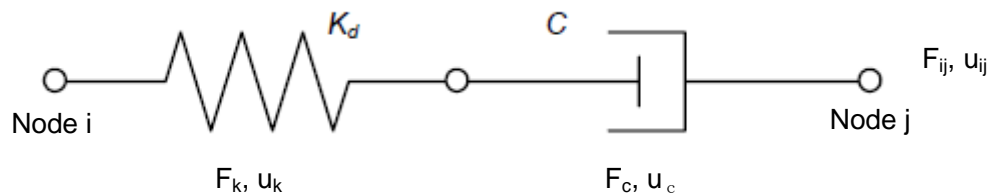

Figure 3-8-4 Maxwell model

Since the elastic spring and the dashpot are connected in a series,

$$F_k = F_c = F_{ij} \tag{3-8-1}$$

where,
 F_k : force of the elastic spring
 F_c : force of the dashpot
 F_{ij} : force between i-j nodes

The force of the elastic spring, F_k , is obtained as,

$$F_k = K_d u_k = K_d (u_{ij} - u_c) \quad (3-8-2)$$

where, u_k : relative displacement of the elastic spring
 u_c : relative displacement of the dashpot
 u_{ij} : relative displacement between i-j nodes

For an oil damper, the force-velocity relationship of the dashpot is defined as shown in Figure 3-8-5.

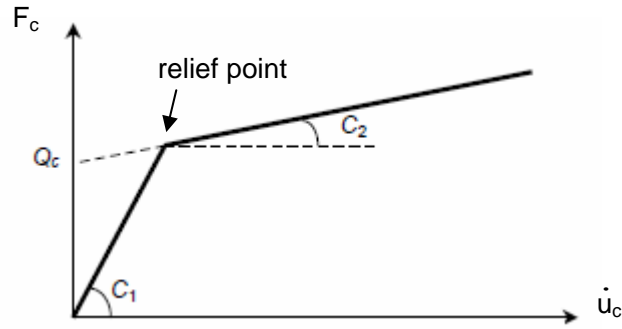

Figure 3-8-5 Dashpot element

The force of the dashpot after the relief point is,

$$F_c = C_2 \dot{u}_c + Q_c \quad (3-8-3)$$

Substituting Equations (3-8-2) and (3-8-3) into (3-8-1)

$$K_d (u_{ij} - u_c) = C_2 \dot{u}_c + Q_c \quad (3-8-4)$$

When the time interval Δt is small enough, the velocity at time t can be expressed as,

$$\dot{u}_c(t) = \frac{\Delta u_c(t)}{\Delta t} \quad (3-8-5)$$

$$\Delta u_c(t) = u_c(t) - u_c(t - \Delta t) \quad (3-8-6)$$

Substituting above equations into Equation (3-8-4),

$$\Delta u_c(t) = \frac{K_d (u_{ij}(t) - u_c(t - \Delta t)) - Q_c}{\frac{C_2}{\Delta t} + K_d} \quad (3-8-7)$$

The algorithm to obtain the force $F_{ij}(t)$ from $u_{ij}(t)$ is as follows:

- 1) Evaluate $\Delta u_c(t)$ from Equation (3-8-7)
- 2) Evaluate $u_c(t)$ from Equation (3-8-6)
- 3) Evaluate $F_{ij}(t)$ from Equation (3-8-2)

Before the relief point of the dashpot, Equation (3-8-7) will be obtained by changing $C_2 \rightarrow C_1$, $Q_c = 0$ as

$$\Delta u_c(t) = \frac{K_d (u_{ij}(t) - u_c(t - \Delta t))}{\frac{C_1}{\Delta t} + K_d} \quad (3-8-8)$$

When the velocity of the dashpot is over the negative relief point, Equation (3-8-7) will be obtained by changing $Q_c \rightarrow -Q_c$,

$$\Delta u_c(t) = \frac{K_d (u_{ij}(t) - u_c(t - \Delta t)) + Q_c}{\frac{C_2}{\Delta t} + K_d} \quad (3-8-9)$$

In case there is no elastic spring,

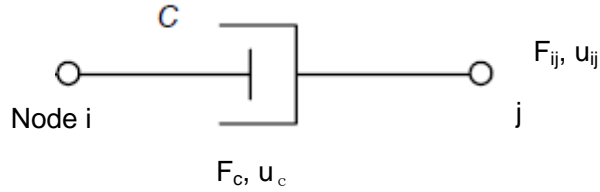

Figure 3-8-6 Dashpot element without elastic spring

$$u_{ij}(t) = u_c(t)$$

$$F_{uj} = F_c = C_2 \dot{u}_c + Q_c$$

$$\dot{u}_c(t) = \frac{\Delta u_c(t)}{\Delta t} = \frac{\Delta u_{ij}(t)}{\Delta t}$$

Therefore,

$$F_{ij}(t) = C_2 \frac{\Delta u_{ij}(t)}{\Delta t} + Q_c \quad (3-8-10)$$

Before the relief point of the dashpot,

$$F_{ij}(t) = C_1 \frac{\Delta u_{ij}(t)}{\Delta t} \quad (3-8-11)$$

When the velocity of the dashpot is over the negative relief point,

$$F_{ij}(t) = C_2 \frac{\Delta u_{ij}(t)}{\Delta t} - Q_c \quad (3-8-12)$$

(2) Algorithm for viscous damper devise

Figure 3-8-7 shows the Maxwell model with an elastic spring with stiffness, K_d , and a dashpot with damping coefficient, C .

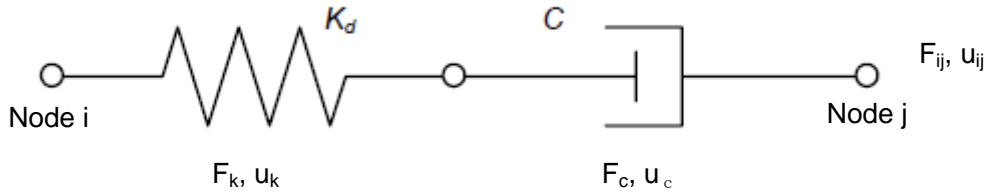

Figure 3-8-7 Maxwell model

Since the elastic spring and the dashpot are connected in a series,

$$F_k = F_c = F_{ij} \quad (3-8-13)$$

where, F_k : force of the elastic spring
 F_c : force of the dashpot
 F_{ij} : force between i-j nodes

The force of the elastic spring, F_k , is obtained as,

$$F_k = K_d u_k = K_d (u_{ij} - u_c) \quad (3-8-14)$$

where, u_k : relative displacement of the elastic spring
 u_c : relative displacement of the dashpot
 u_{ij} : relative displacement between i-j nodes

For a viscous damper, the force-velocity relationship of the dashpot is defined as shown in Figure 3-8-8,

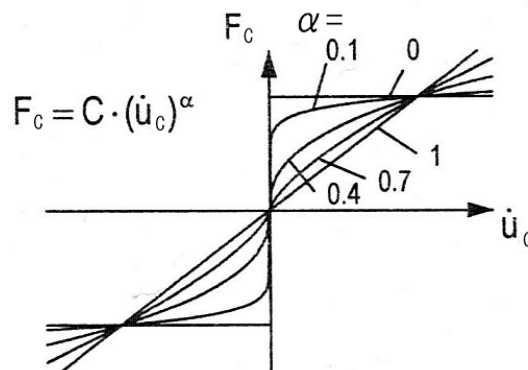

Figure 3-8-8 Dashpot element

That is,

$$F_c = C \operatorname{sgn}(u_c(t)) |\dot{u}_c(t)|^\alpha \quad (3-8-15)$$

From Equations (3-8-13) and (3-8-14)

$$\frac{F_{ij}(t)}{K_d} + u_c(t) = u_{ij}(t) \quad (3-8-16)$$

Taking time differential and substituting Equation (3-8-15) give

$$\frac{\dot{F}_{ij}(t)}{K_d} + \text{sgn}(F_{ij}(t)) \left(\frac{|F_{ij}(t)|}{C} \right)^{1/\alpha} = \dot{u}_{ij}(t) \quad (3-8-17)$$

The numerical integration method, Runge-Kutta Method, can be used to solve the Equation (3-8-17).

In general, the solution of the differential equation, $\dot{y}(t) = f(y, t)$, is obtained by Runge-Kutta Method as follows:

$$y_{n+1} = y_n + \frac{1}{6}(k_0 + 2k_1 + 2k_2 + k_3) \quad (3-8-18)$$

$$k_0 = f(y_n, t_n)\Delta t$$

$$k_1 = f(y_n + k_0/2, t_n + \Delta t/2)\Delta t$$

$$k_2 = f(y_n + k_1/2, t_n + \Delta t/2)\Delta t$$

$$k_3 = f(y_n + k_2, t_n + \Delta t)\Delta t$$

Equation (3-8-17) can be written as

$$\dot{F}_{ij}(t) = \left(\dot{u}_{ij}(t) - \text{sgn}(F_{ij}(t)) \left(\frac{|F_{ij}(t)|}{C} \right)^{1/\alpha} \right) K_d \quad (3-8-19)$$

Applying Runge-Kutta Method gives the following algorithm,

$$F_{ij}(t_{n+1}) = F_{ij}(t_n) + \frac{1}{6}(k_0(t_n) + 2k_1(t_n) + 2k_2(t_n) + k_3(t_n)) \quad (3-8-20)$$

$$k_0 = \left(\dot{u}_{ij}(t_n) - \text{sgn}(F_{ij}(t_n)) \left(\frac{|F_{ij}(t_n)|}{C} \right)^{1/\alpha} \right) K_d \Delta t$$

$$k_1 = \left(\dot{u}_{ij}(t_n + \Delta t/2) - \text{sgn}(F_{ij}(t_n) + k_0/2) \left(\frac{|F_{ij}(t_n) + k_0/2|}{C} \right)^{1/\alpha} \right) K_d \Delta t$$

$$k_2 = \left(\dot{u}_{ij}(t_n + \Delta t/2) - \text{sgn}(F_{ij}(t_n) + k_1/2) \left(\frac{|F_{ij}(t_n) + k_1/2|}{C} \right)^{1/\alpha} \right) K_d \Delta t$$

$$k_3 = \left(\dot{u}_{ij}(t_n + \Delta t) - \text{sgn}(F_{ij}(t_n) + k_2) \left(\frac{|F_{ij}(t_n) + k_2|}{C} \right)^{1/\alpha} \right) K_d \Delta t$$

In this algorithm, it is assumed as,

$$\dot{u}_{ij}(t_n + \Delta t / 2) = \frac{\dot{u}_{ij}(t_n) + \dot{u}_{ij}(t_n + \Delta t)}{2} \quad (3-8-21)$$

4. Freedom Vector

4.1 Node freedom

Each node has six degrees of freedom and the freedom number is defined as shown in Figure 4-1-1.

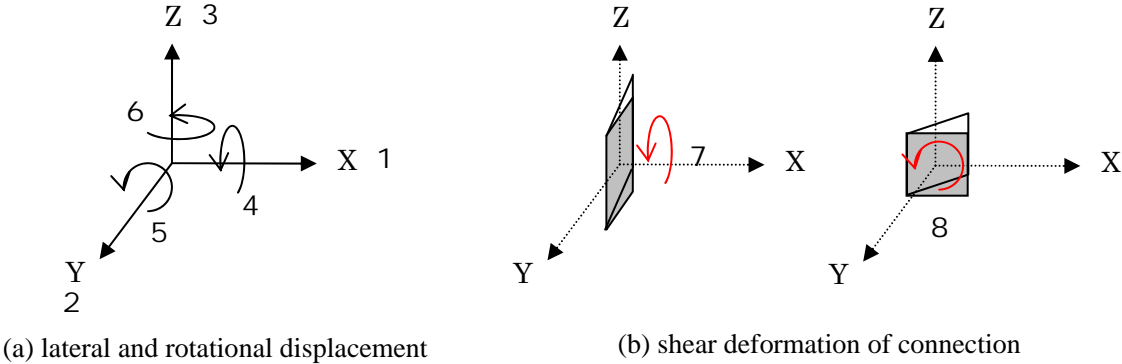

Figure 4-1-1 Global coordinate

4.2 Freedom vector

The freedom vector is defined to indicate the number of all freedoms of the structure, where the restrained freedom is set to be zero. For the structure in Figure 4-2-1, the freedom vector has zero components for the fixed nodes (Nodes 1-4) and eight components for other nodes (Nodes 5-8). Therefore, the total number of freedom of the structure is $8 \times 4 = 32$.

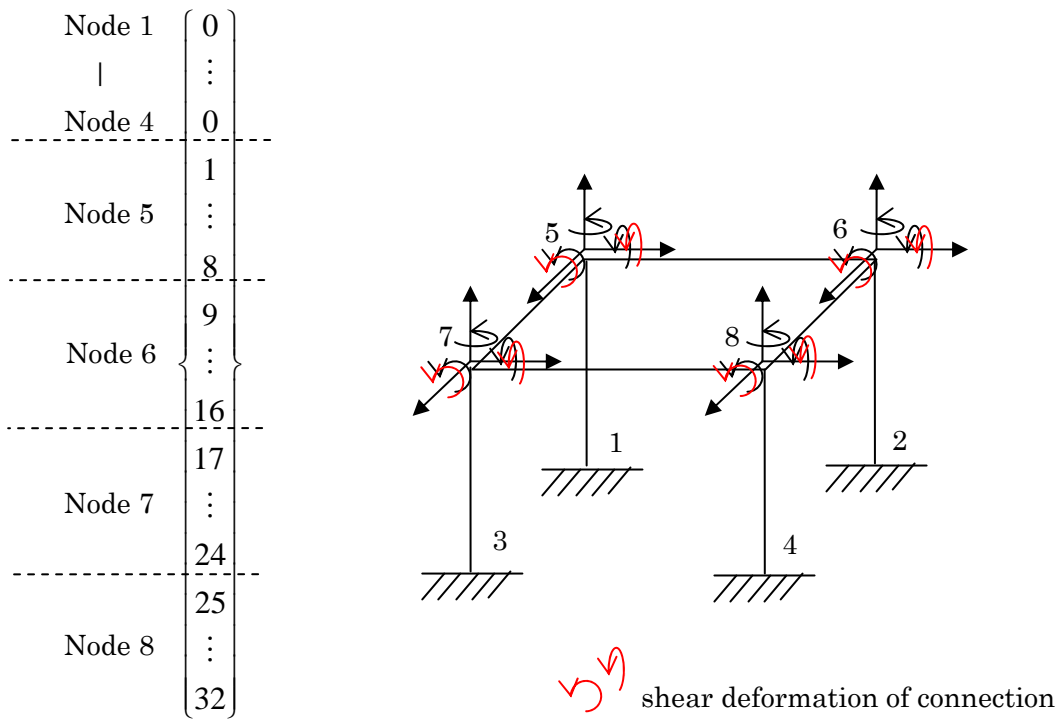

Figure 4-2-1 Example of the freedom vector

4.3 Dependent freedom

(1) Rigid floor assumption

In the default setting, the floor diaphragm is assumed to be rigid for the in-plane deformation. Therefore, the in-plane freedoms at the nodes in a floor are represented by the freedoms at the center of gravity of the same floor.

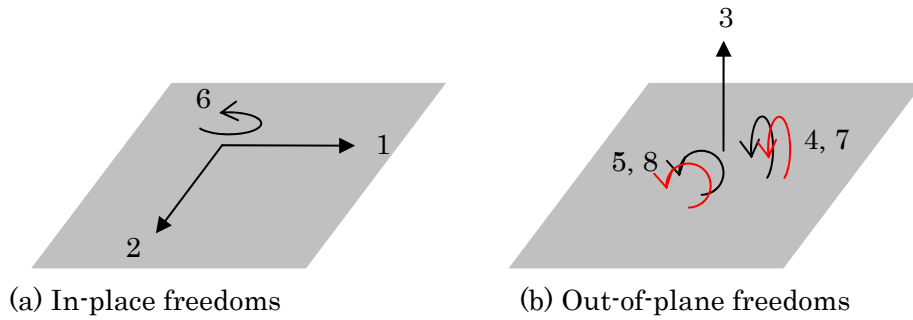

Figure 4-3-1 In-plane and out-of-plane freedom

For example, the in-plane freedoms at the node, A, in Figure 4-3-2 are expressed by the in-plane freedoms at the center of gravity, G, as follows:

$$\begin{Bmatrix} u_{xA} \\ u_{yA} \\ \theta_{zA} \end{Bmatrix} = \begin{bmatrix} 1 & 0 & l_{yA} \\ 0 & 1 & -l_{xA} \\ 0 & 0 & 1 \end{bmatrix} \begin{Bmatrix} u_{xG} \\ u_{yG} \\ \theta_{zG} \end{Bmatrix} \quad (4-3-1)$$

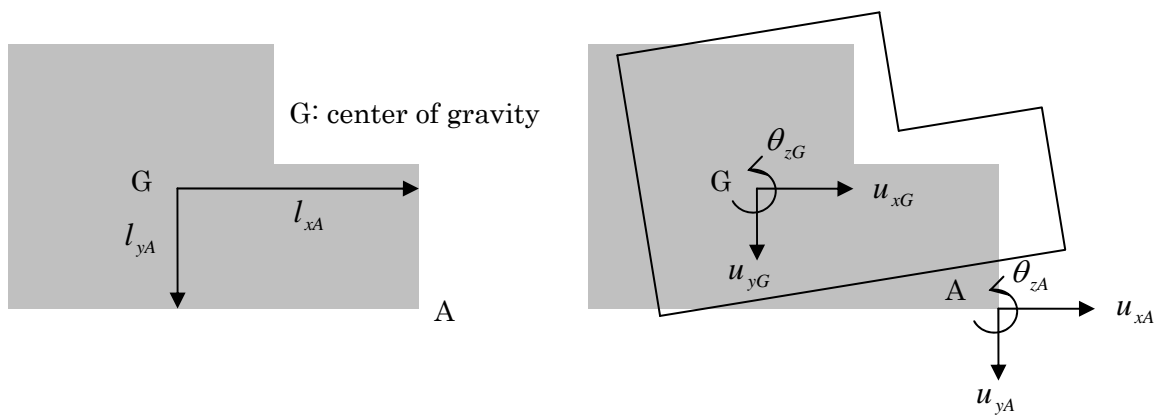
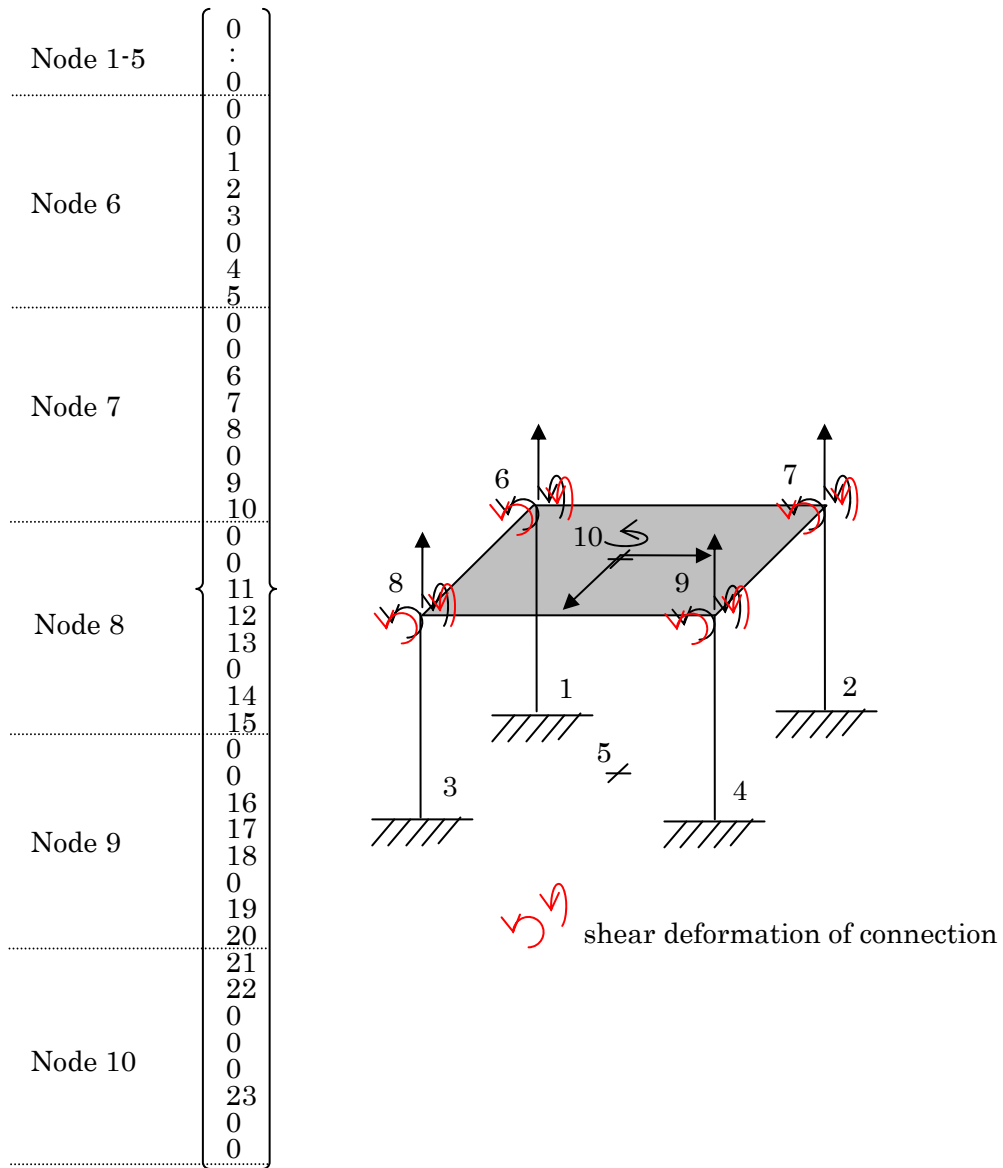

Figure 4-3-2 Rigid floor assumption

For the structure in Figure 4-3-2, in addition to the original nodes, a new node for the center of gravity is added to the each floor. Also, the freedom vector has zero components for the in-plane freedoms at the nodes except the center of gravity. Therefore, the total number of freedom is 23.



Freedom vector

Figure 4-3-2 Example of the freedom vector with rigid floor assumption

(2) Including wall element

The wall element model has rigid beams at the top and bottom of the wall, therefore, as shown in Figure 4-3-3, the rotation angles in the wall panel plane, θ_{y1} and θ_{y2} , are dependent to the vertical displacements, δ_{z1} and δ_{z2} . Also, the horizontal displacement in the wall panel plane, u_{x2} , is dependent to the displacement, u_{x1} . The connection is assumed to be rigid.

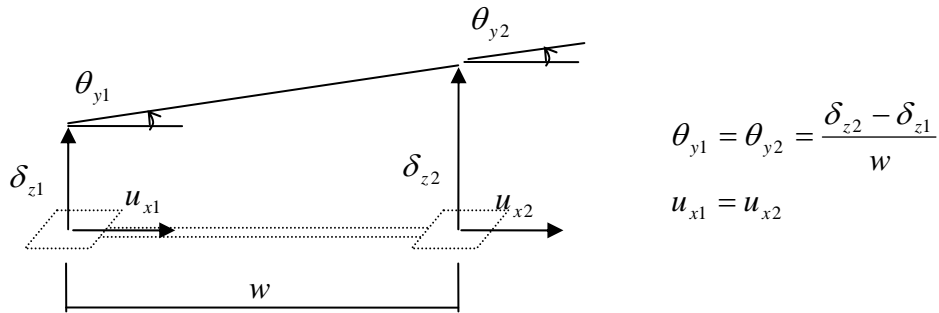

Figure 4-3-3 Relationship between node displacements for a wall element (X-wall)

In a matrix form;

$$\begin{Bmatrix} u_{x1} \\ \theta_{y1} \\ \theta_{y2} \end{Bmatrix} = \begin{bmatrix} 1 & 0 & 0 \\ 0 & -1/w & 1/w \\ 0 & -1/w & 1/w \end{bmatrix} \begin{Bmatrix} u_{x2} \\ \delta_{z1} \\ \delta_{z2} \end{Bmatrix} \quad (4-3-2)$$

In case of Y-direction wall, the relationship can be written as;

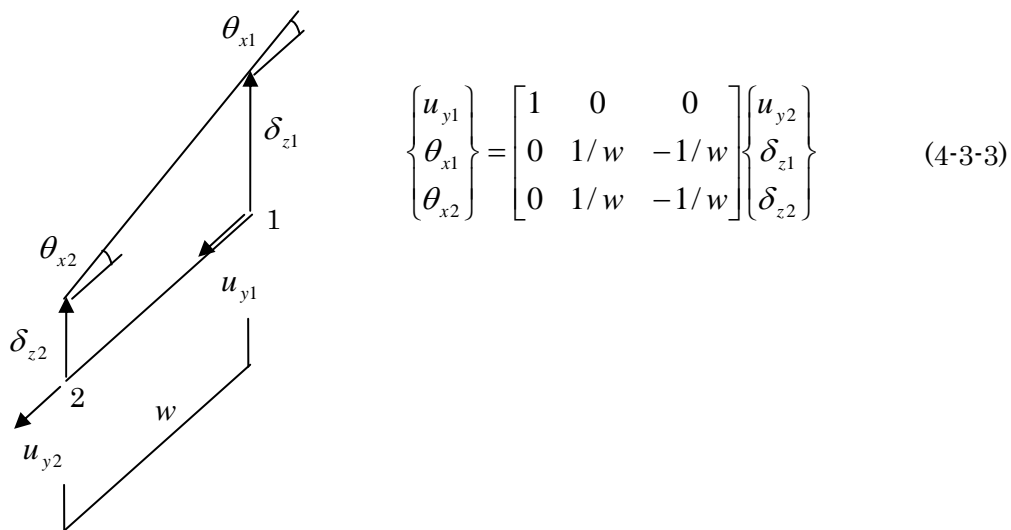

Figure 4-3-4 Relationship between node displacements for a wall element (Y-wall)

For example, for the structure in Figure 4-3-4, the total number of freedom is 17.

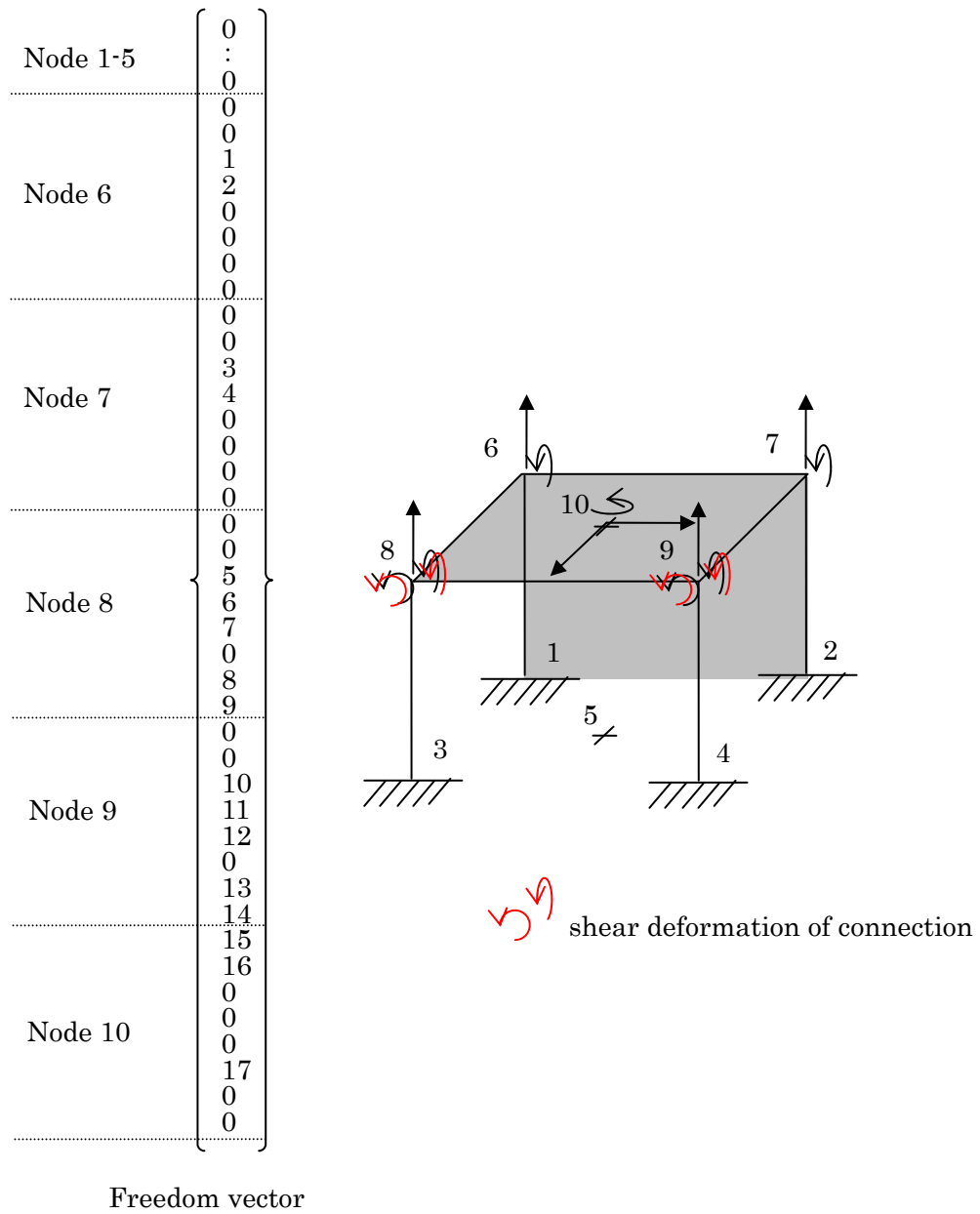
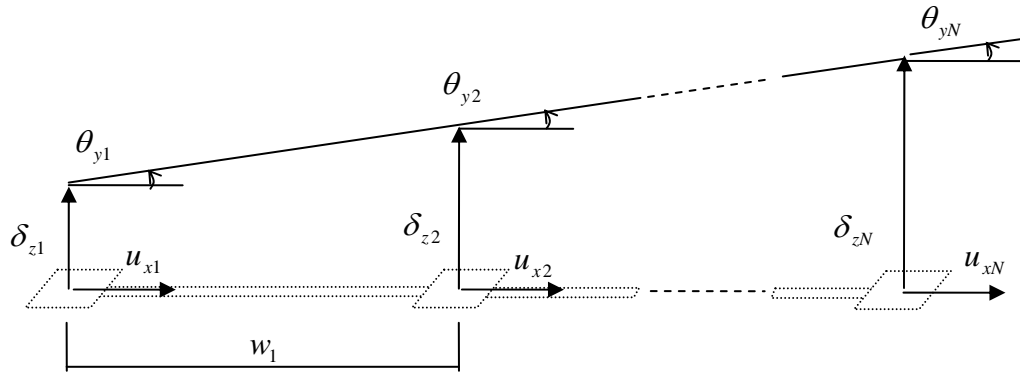

Figure 4-3-5 Example of the freedom vector with a wall element

(3) Series of walls

In case several walls are joined together in series, it is assumed that all walls are connected by rigid beams at the top and bottom. Therefore, as shown in Figure 4-3-6, the rotation angles in the wall panel plane, θ_{y1} and θ_{y2} , are dependent to the vertical displacements, δ_{z1} and δ_{z2} . Also, the horizontal displacement in the wall panel plane, u_{x2} , is dependent to the displacement, u_{x1} . The connection is assumed to be rigid.



$$\theta_{y1} = \theta_{y2} = \dots = \theta_{yN} = \frac{\delta_{zN} - \delta_{z1}}{L}, \quad L = \sum_{k=1}^{N-1} w_k$$

$$\delta_{zi} = \delta_{z1} + \theta_{yi} L_i = (1 - L_i/L)\delta_{z1} + (L_i/L)\delta_{zN}, \quad L_i = \sum_{k=1}^{i-1} w_k$$

$$u_{x1} = u_{x2} = \dots = u_{xN}$$

Figure 4-3-6 Series of wall connected by a rigid beam (X-wall)

In a matrix form;

$$\theta_{yi} = \begin{bmatrix} -1/L & 1/L \end{bmatrix} \begin{Bmatrix} \delta_{z1} \\ \delta_{zN} \end{Bmatrix} \quad (4-3-4)$$

$$\delta_{zi} = \begin{bmatrix} 1 - L_i/L & L_i/L \end{bmatrix} \begin{Bmatrix} \delta_{z1} \\ \delta_{zN} \end{Bmatrix} \quad (4-3-5)$$

In case of Y-direction wall, the relationship can be written as;

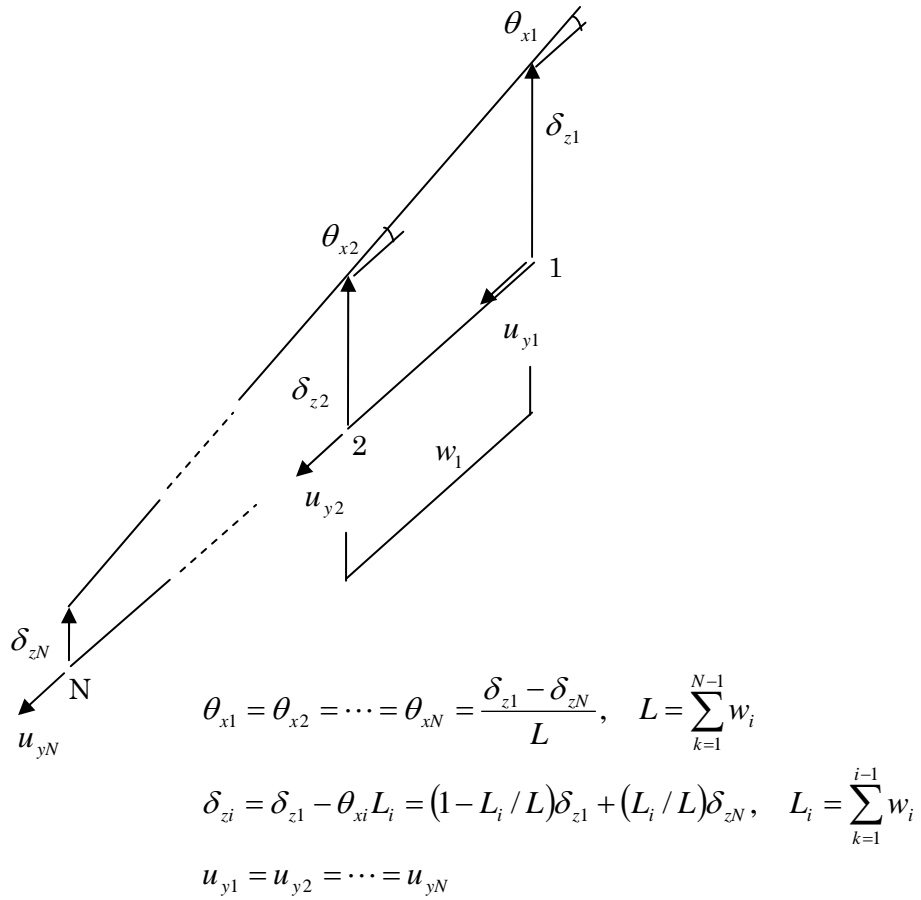

Figure 4-3-7 Series of wall connected by a rigid beam (Y-wall)

In a matrix form;

$$\theta_{xi} = \begin{bmatrix} 1/L & -1/L \end{bmatrix} \begin{Bmatrix} \delta_{z1} \\ \delta_{zN} \end{Bmatrix} \quad (4-3-6)$$

$$\delta_{zi} = \begin{bmatrix} 1 - L_i/L & L_i/L \end{bmatrix} \begin{Bmatrix} \delta_{z1} \\ \delta_{zN} \end{Bmatrix} \quad (4-3-7)$$

Initial conditions of $[N_I]$ and $[F_I]$ are:

$$[N_I] = i \begin{bmatrix} i & 0 & 0 \\ 0 & 0 & 0 \\ 0 & 0 & 0 \end{bmatrix}, \quad [F_I] = i \begin{bmatrix} 1 & 0 & 0 \\ 0 & 0 & 0 \\ 0 & 0 & 0 \end{bmatrix}$$

4.4 Formulation of independent displacement of the element

In Figure 4-4-1 (rigid connection), the element node displacement vector of the beam element between Node 8 and Node 9 is,

$$\{u_{z8} \quad u_{z9} \quad \theta_{y8} \quad \theta_{y9} \quad \delta_{x8} \quad \delta_{x9}\}^T \quad (4-4-1)$$

Those displacements correspond to the location numbers in the freedom vector as;

$$\{u_{z8} \quad u_{z9} \quad \theta_{y8} \quad \theta_{y9} \quad \delta_{x8} \quad \delta_{x9}\}^T \Rightarrow \{45 \quad 51 \quad 47 \quad 53 \quad 43 \quad 49\}^T \quad (4-4-2)$$

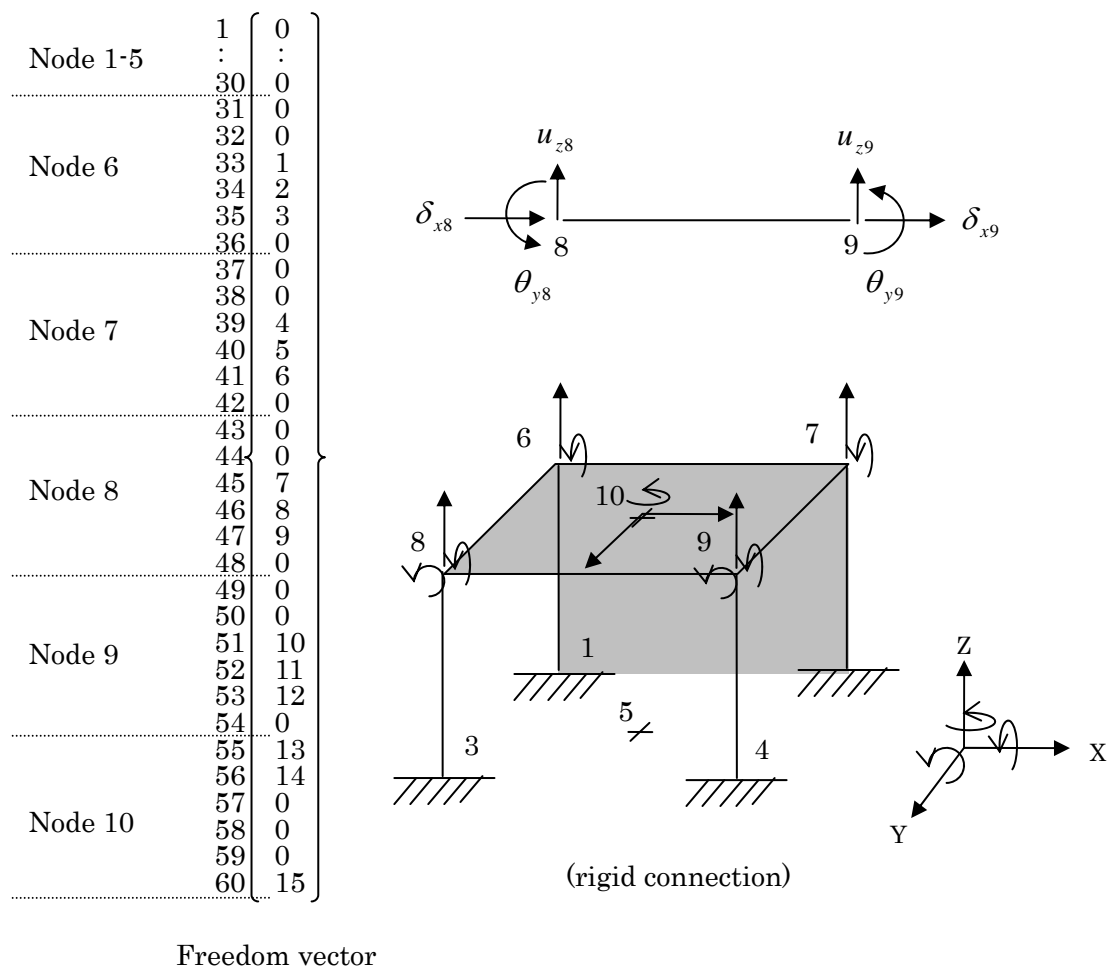

Figure 4-4-1 Example of location matrix for beam element

From rigid floor assumption, the components of independent matrices, $[N_I]$ and $[F_I]$ will be;

$$[N_I] = \begin{Bmatrix} \vdots \\ 43 \\ 45 \\ 47 \\ 49 \\ 51 \\ 53 \\ \vdots \end{Bmatrix} \begin{bmatrix} 55 & 60 & 0 & 0 \\ 45 & 0 & 0 & 0 \\ 47 & 0 & 0 & 0 \\ 55 & 60 & 0 & 0 \\ 51 & 0 & 0 & 0 \\ 53 & 0 & 0 & 0 \end{bmatrix}, \quad [F_I] = \begin{Bmatrix} \vdots \\ 43 \\ 45 \\ 47 \\ 49 \\ 51 \\ 53 \\ \vdots \end{Bmatrix} \begin{bmatrix} 1 & l_{y8} & 0 \\ 1 & 0 & 0 \\ 1 & 0 & 0 \\ 1 & l_{y9} & 0 \\ 1 & 0 & 0 \\ 1 & 0 & 0 \end{bmatrix} \quad (4-4-3)$$

From the matrix, $[N_I]$, the freedoms of (43) and (49) are replaced to the independent freedoms (55) and (60). Therefore, the independent location numbers and freedom numbers of the beam element are:

$$\begin{aligned} & \{u_{z8} \quad u_{z9} \quad \theta_{y8} \quad \theta_{y9} \quad \delta_{x8} \quad \delta_{x9}\}^T \\ & \Rightarrow \{45 \quad 51 \quad 47 \quad 53 \quad 43 \quad 49\}^T \\ & \Rightarrow \{45 \quad 51 \quad 47 \quad 53 \quad 55 \quad 60\}^T; \text{ independent location number} \\ & \Rightarrow \{u_{z8} \quad u_{z9} \quad \theta_{y8} \quad \theta_{y9} \quad u_{x10} \quad \theta_{z10}\}^T \\ & \Rightarrow \{5 \quad 8 \quad 7 \quad 10 \quad 11 \quad 13\}^T; \text{ freedom number} \end{aligned} \quad (4-4-4)$$

The transformation from independent displacements (= global node displacements) to element node displacements is obtained from the matrix, $[F_I]$, as follows:

$$\begin{Bmatrix} u_{z8} \\ u_{z9} \\ \theta_{y8} \\ \theta_{y9} \\ \delta_{x8} \\ \delta_{x9} \end{Bmatrix} = \begin{bmatrix} 1 & & & & & 0 \\ & 1 & & & & \\ & & 1 & & & \\ & & & 1 & & \\ & & & & 1 & l_{y8} \\ 0 & & & & 1 & l_{y9} \end{bmatrix} \begin{Bmatrix} u_{z8} \\ u_{z9} \\ \theta_{y8} \\ \theta_{y9} \\ u_{x10} \\ \theta_{z10} \end{Bmatrix} = [T_{iXB}] \begin{Bmatrix} u_{z8} \\ u_{z9} \\ \theta_{y8} \\ \theta_{y9} \\ u_{x10} \\ \theta_{z10} \end{Bmatrix} \quad (4-4-5)$$

The constitutive equation of the beam element and formulation of global stiffness matrix from element stiffness matrix are shown below:

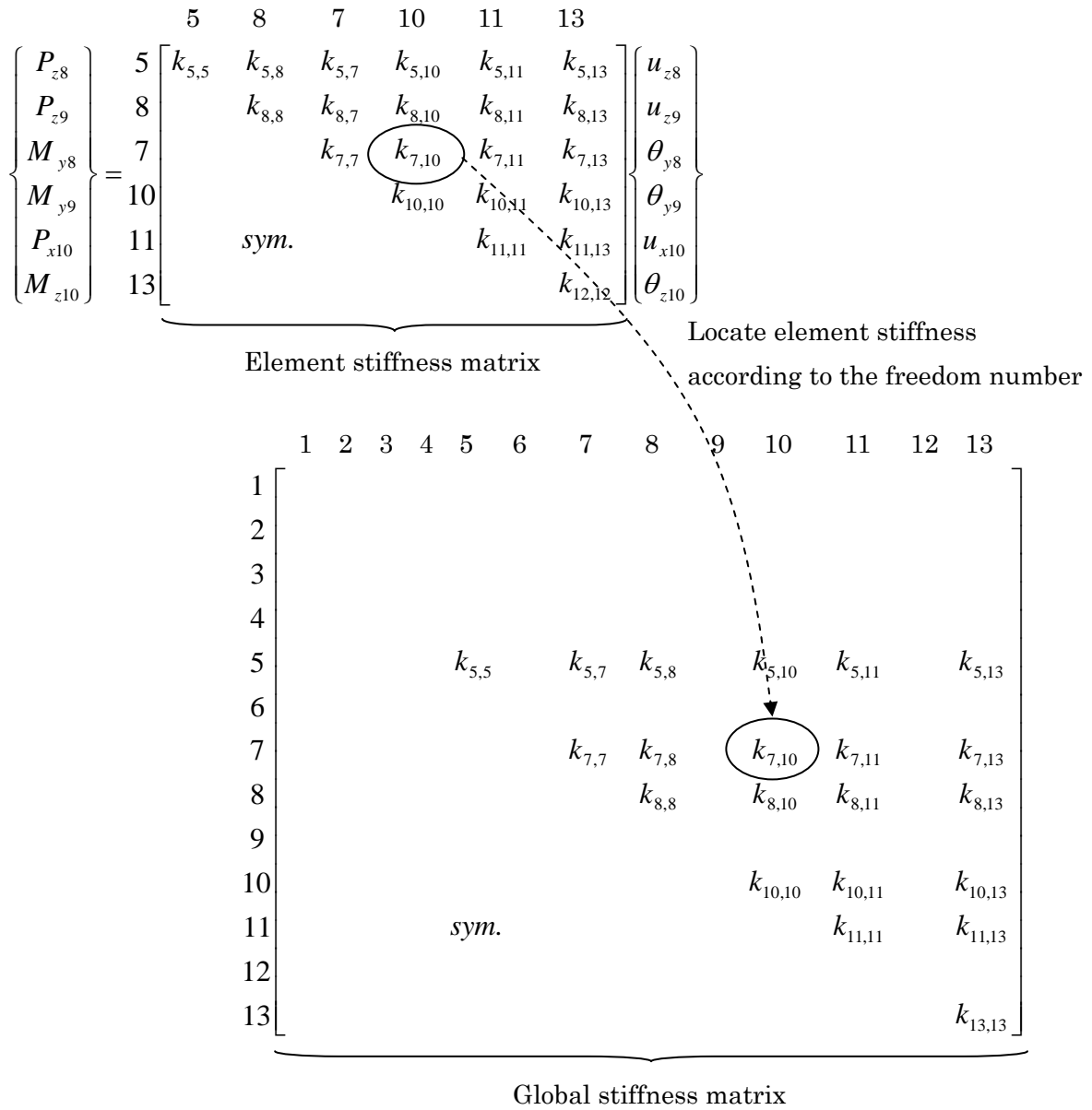

Figure 4-4-2 Formulation of global stiffness matrix

In general, the transformation from independent displacements (= global node displacements) to element node displacements for the X-beam is described as Equation (2-1-10).

$$\begin{Bmatrix} u_{zA} \\ u_{zB} \\ \theta_{yA} \\ \theta_{yB} \\ \delta_{xA} \\ \delta_{xB} \end{Bmatrix} = [T_{ixB}] \begin{Bmatrix} u_1 \\ u_2 \\ \vdots \\ u_n \end{Bmatrix} \quad (2-1-10)$$

And the constitutive equation of the X-beam is also described in Equation (2-1-16).

$$\begin{Bmatrix} P_1 \\ P_2 \\ \vdots \\ P_n \end{Bmatrix} = [K_{xB}] \begin{Bmatrix} u_1 \\ u_2 \\ \vdots \\ u_n \end{Bmatrix} \tag{2-1-16}$$

Using the same procedure in Figure 4-4-2, the element stiffness matrix is added into the global stiffness matrix.

5. Equation of motion

5.1 Mass matrix

In the default setting, the mass at each node is identical and equally distributed as

$$M_i = \frac{1}{N_{floor}} M_{floor} \quad (5-1-1)$$

where, M_i : mass at the node i , M_{floor} : total mass of the floor, N_{floor} : total number of nodes in the floor.

However, you can change the mass at each node depending on the place of the node by setting “proportion to influence area” in Option Menu. In this case, the mass at each node is determined from the following equation:

$$M_i = \frac{A_i}{A_{floor}} M_{floor} \quad (5-1-1)$$

where, A_i : influence area of node i , A_{floor} : total area of the floor. Influence area of the node is different depending on the place of the node as shown in Figure 5-1-1.

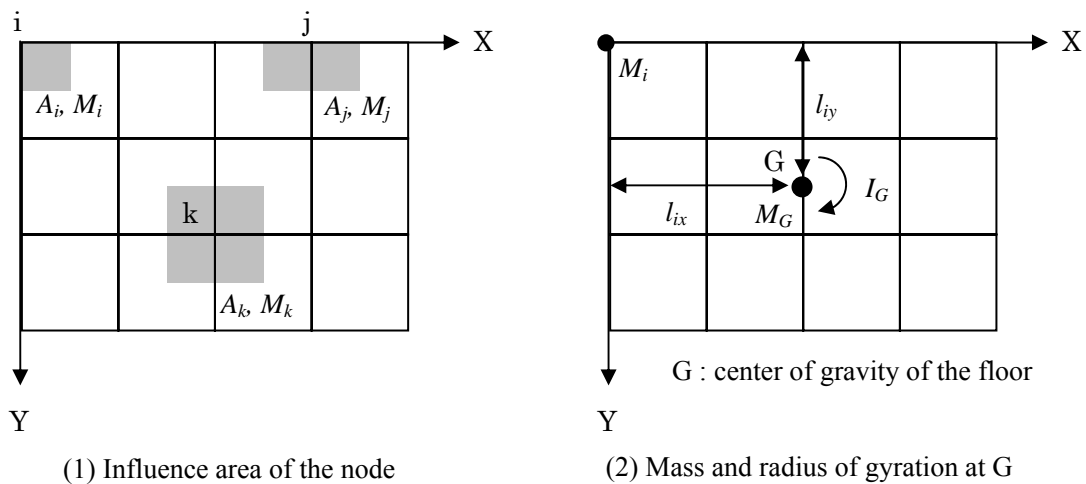

Figure 5-1-1 Mass and radius of gyration at the node

The process to determine the mass based on influence area is as follows:

Step 1. Calculate the slab area (block with cross mark).

Step 2. The are of the block is divided equally to the corner nodes. (Figure 5-1-2.)

Step 3. If there is no corner node, the area is divided equally to the all nodes in a floor. (Figure 5-1-3)

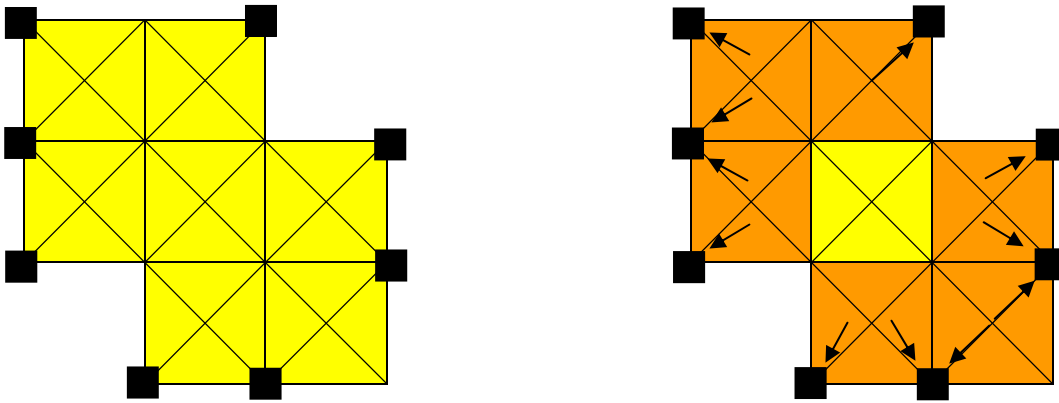

Figure 5-1-2. Influence area of the node (red)

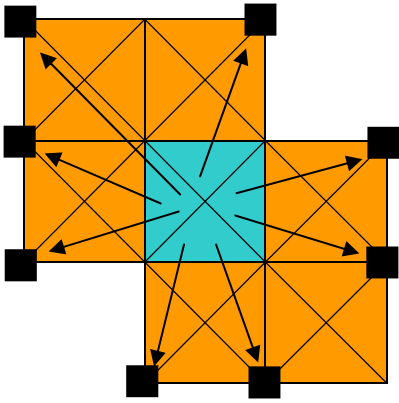
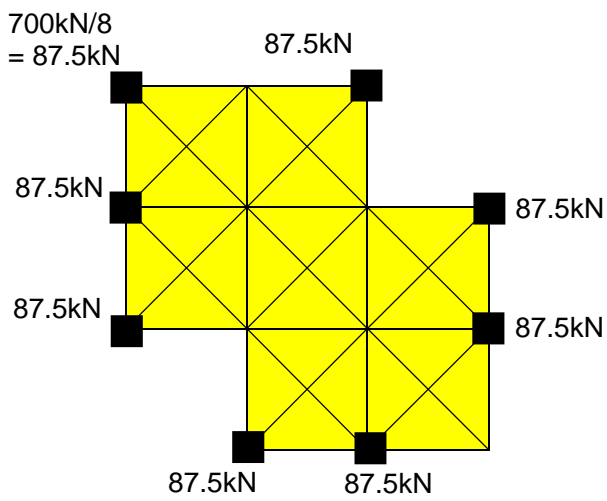
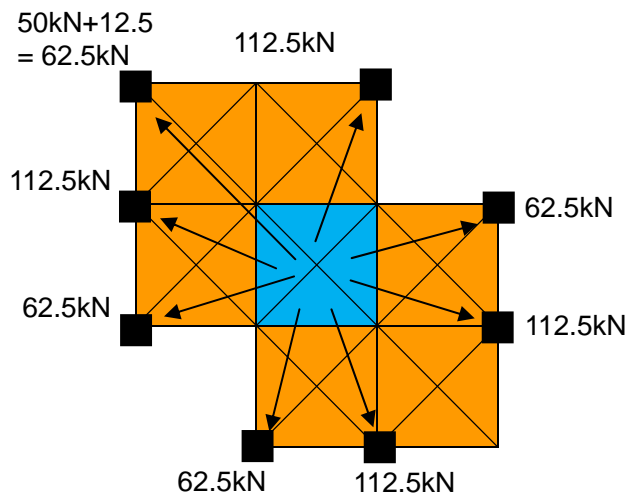

Figure 5-1-3. Distribution of the rest area

Example) Floor weight = 700kN



(a) Same for all nodes



(b) Proportional to influence area

Figure 5-1-4 Example of mass distribution

In case of rigid floor assumption, in-plane freedoms at the nodes are dependent to the freedoms at the center of gravity of the floor. Therefore, the mass at the center of gravity, M_G , is,

$$M_G = M_{floor} \tag{5-1-2}$$

The radius of gyration at the center of gravity, I_G , is obtained from the following equation:

$$I_G = \sum_i^N M_i (I_{ix}^2 + I_{iy}^2) \tag{5-1-3}$$

where, N is the total number of the nodes at the floor. The radius of gyrations at other nodes are,

$$I_i = 0, \quad i = 1, \dots, N \tag{5-1-4}$$

The mass matrix is obtained as,

$$[M] = \begin{bmatrix} \ddots & & & & & & & & & & & & 0 \\ & \ddots & & & & & & & & & & & \\ & & M_i & & & & & & & & & & \\ & & & M_i & & & & & & & & & \\ & & & & M_i & & & & & & & & \\ & & & & & I_i & & & & & & & \\ & & & & & & I_i & & & & & & \\ & & & & & & & I_i & & & & & \\ & & & & & & & & \ddots & & & & 0 \\ & & & & & & & & & \ddots & & & \\ & & & & & & & & & & 0 & & \\ & & & & & & & & & & & \ddots & \\ & & & & & & & & & & & & \ddots \\ & & & & & & & & & & & & & 0 \end{bmatrix} \Rightarrow \begin{bmatrix} \vdots \\ \vdots \\ \vdots \\ M_i \\ M_i \\ M_i \\ I_i \\ I_i \\ I_i \\ \vdots \\ \vdots \\ \vdots \\ \vdots \\ \vdots \end{bmatrix} \tag{5-1-5}$$

Since the mass matrix has only diagonal components, those components are saved in one-dimension vector. For example, the mass vector of the structure in Figure 5-1-5 will be as follows:

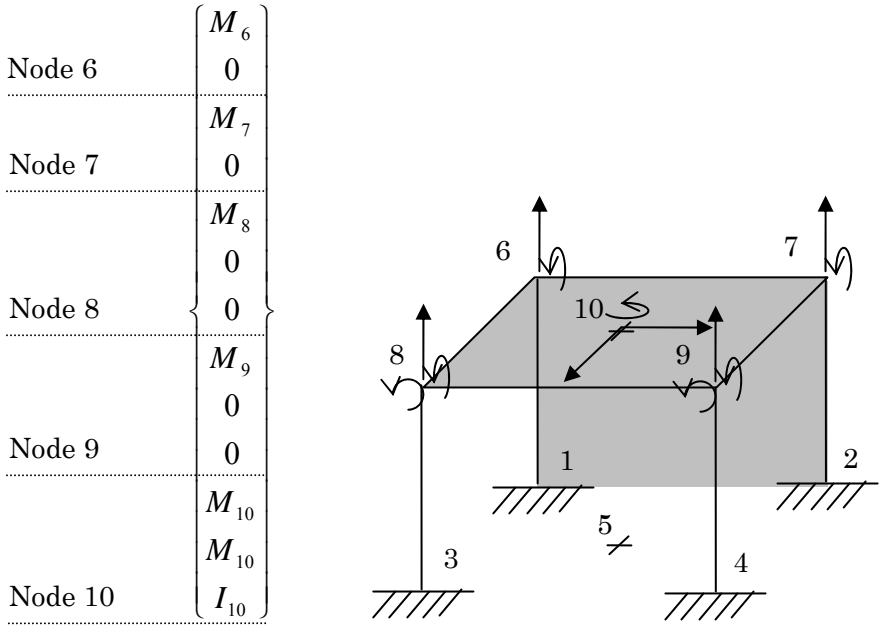

Figure 5-1-5 Example of mass vector

5.2 Stiffness matrix

As shown in Figure 4-4-2, the global stiffness matrix $[K]$ is formulated from element stiffness matrices.

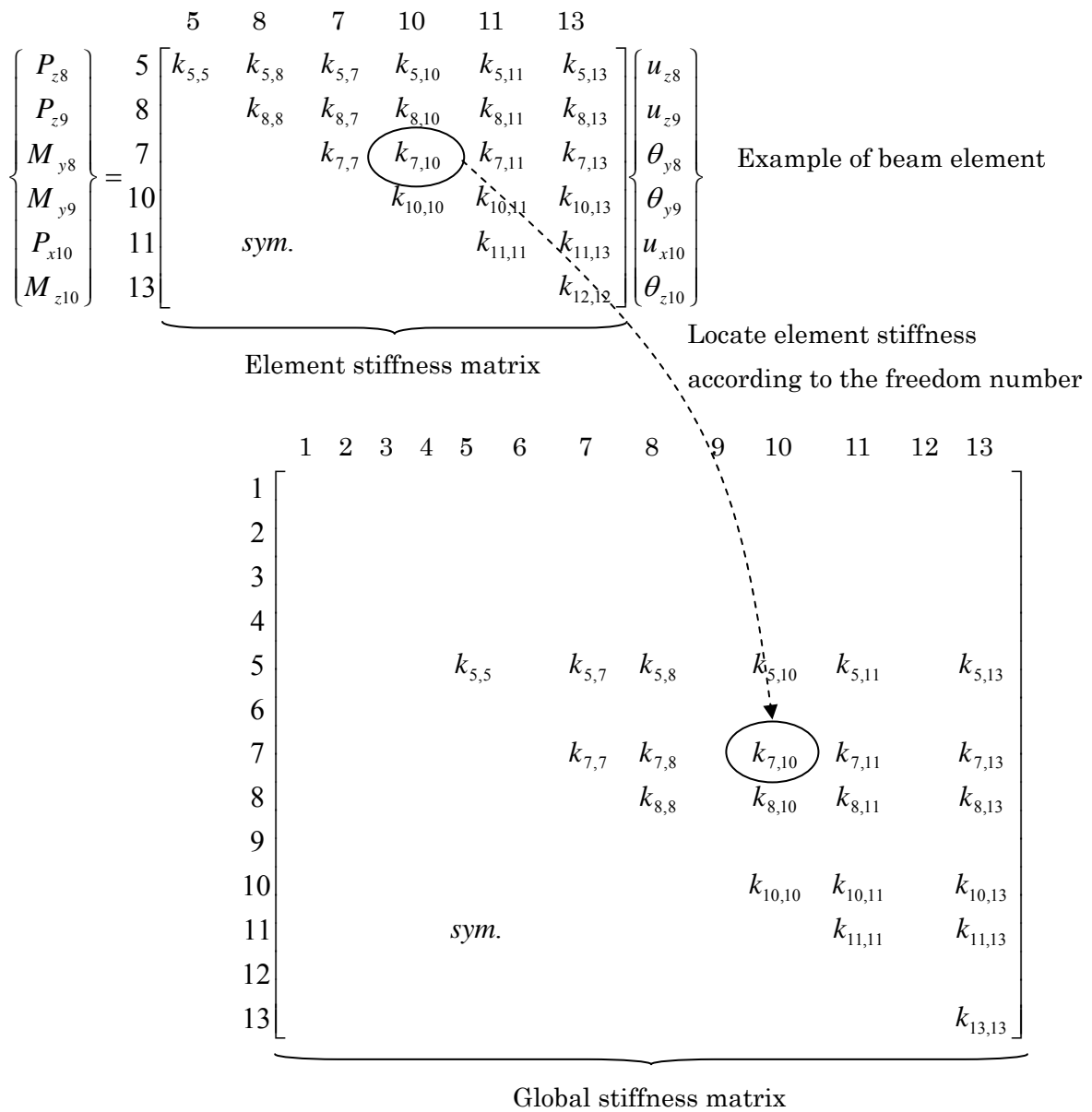

Figure 5-2-1 Formulation of global stiffness matrix

5.3 Damping matrix

In STERA 3D program, the damping matrix is formulated in the following way:

1) Proportional damping to initial stiffness matrix

The damping matrix is defined from the following equation:

$$[C] = \frac{2h}{\omega_1} [K_0] \quad (5-3-1)$$

where, h: damping factor, ω_1 : circular frequency of the first natural mode, $[K_0]$: the initial stiffness.

2) Proportional damping to spontaneous stiffness matrix

The damping matrix is defined from the following equation:

$$[C] = \frac{2h}{\omega} [K_p] \quad (5-3-2)$$

where, h: damping factor, ω_1 : circular frequency of the first natural mode, $[K_p]$: the spontaneous stiffness changing according to the nonlinearity of structural elements.

3) Damping matrix of a base isolation building

In an actual design practice for the base isolation buildings, it is common to assume zero viscous damping for the base isolation floor. In this case, the damping matrix is defined as:

$$[C] = \frac{2h}{\omega} [K_{upper}] \quad (5-3-3)$$

where, $[K_{upper}]$: the stiffness matrix consisted with upper structures without base isolation elements.

4) Damping matrix from viscous damper devices

If there are some viscous damper devices in a structure, in addition to the proportional damping matrix, the global damping matrix formulated from element damping matrices are considered as:

$$[C] = [C_{pro}] + [C_v] \quad (5-3-4)$$

where, $[C_{pro}]$: the proportional damping matrix, $[C_v]$: the global damping matrix formulated from element damping matrices in the same manner of the global stiffness matrix.

5.4 Input ground acceleration

Earthquake ground motions are defined as three components acceleration; \ddot{X}_0 , \ddot{Y}_0 and \ddot{Z}_0 , in X, Y and Z directions. The inertia forces at node i are defined as,

$$\begin{Bmatrix} \vdots \\ \vdots \\ -M_i(\ddot{u}_{xi} + \ddot{X}_0) \\ -M_i(\ddot{u}_{yi} + \ddot{Y}_0) \\ -M_i(\ddot{\delta}_{zi} + \ddot{Z}_0) \\ -I_i\ddot{\theta}_{xi} \\ -I_i\ddot{\theta}_{yi} \\ -I_i\ddot{\theta}_{zi} \\ \vdots \\ \vdots \end{Bmatrix} = -[M] \begin{Bmatrix} \vdots \\ \vdots \\ \ddot{u}_{xi} \\ \ddot{u}_{yi} \\ \ddot{\delta}_{zi} \\ \ddot{\theta}_{xi} \\ \ddot{\theta}_{yi} \\ \ddot{\theta}_{zi} \\ \vdots \\ \vdots \end{Bmatrix} - [M] \begin{bmatrix} \vdots \\ \vdots \\ 1 & 0 & 0 \\ 0 & 1 & 0 \\ 0 & 0 & 1 \\ 0 & 0 & 0 \\ 0 & 0 & 0 \\ 0 & 0 & 0 \\ \vdots \\ \vdots \end{bmatrix} \begin{Bmatrix} \ddot{X}_0 \\ \ddot{Y}_0 \\ \ddot{Z}_0 \end{Bmatrix} = -[M] \begin{Bmatrix} \vdots \\ \vdots \\ \ddot{u}_{xi} \\ \ddot{u}_{yi} \\ \ddot{\delta}_{zi} \\ \ddot{\theta}_{xi} \\ \ddot{\theta}_{yi} \\ \ddot{\theta}_{zi} \\ \vdots \\ \vdots \end{Bmatrix} - [M][U] \begin{Bmatrix} \ddot{X}_0 \\ \ddot{Y}_0 \\ \ddot{Z}_0 \end{Bmatrix} \quad (5-4-1)$$

For example, the components of the matrix $[U]$ of the structure in Figure 5-4-1 will be as follows:

	\ddot{X}_0	\ddot{Y}_0	\ddot{Z}_0
Node 6	0	0	1
Node 7	0	0	0
Node 8	0	0	1
Node 9	0	0	0
Node 10	1	0	0

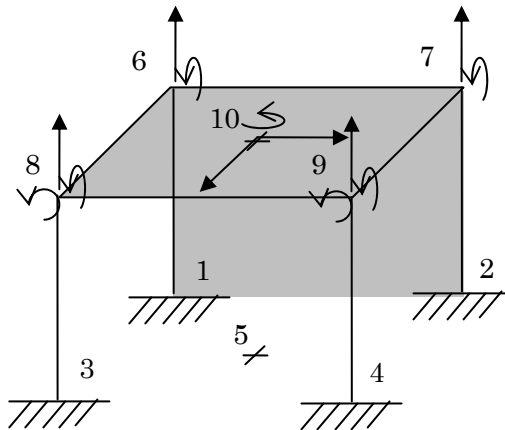

Figure 5-4-1 Components of the matrix $[U]$

5.5 Equation of motion

Equilibrium condition of the structure under earthquake ground motion is:

$$\underbrace{[C]\{\dot{u}\}}_{\text{Damping force}} + \underbrace{[K]\{u\}}_{\text{Restoring force}} = \underbrace{-[M]\{\ddot{u}\} - [M][U] \begin{Bmatrix} \ddot{X}_0 \\ \ddot{Y}_0 \\ \ddot{Z}_0 \end{Bmatrix}}_{\text{Inertia force}} \quad (5-5-1)$$

Finally the equation of motion is obtained as:

$$[M]\{\ddot{u}\} + [C]\{\dot{u}\} + [K]\{u\} = -[M][U] \begin{Bmatrix} \ddot{X}_0 \\ \ddot{Y}_0 \\ \ddot{Z}_0 \end{Bmatrix} = \{P\} \quad (5-5-2)$$

5.6 Numerical integration method

Two numerical integration methods are prepared; one is the Newmark- β method with incremental formulation using a step-by-step stiffness matrix, and another one is the Force correction method using a step-by-step stiffness and a force vector together. In case it is difficult to define the step-by-step stiffness of the element such as the case of using a viscous damper element, automatically the Force correction method is selected.

a) Newmark- β method

The incremental formulation for the equation of motion of a structural system is,

$$[M]\{\Delta a_i\} + [C]\{\Delta v_i\} + [K]\{\Delta d_i\} - \{\Delta f\} = \{\Delta p_i\} \quad (5-6-1)$$

where, $[M]$, $[C]$ and $[K]$ are the mass, damping and stiffness matrices. $\{\Delta d_i\}$, $\{\Delta v_i\}$, $\{\Delta a_i\}$ and $\{\Delta p_i\}$ are the increments of the displacement, velocity, acceleration and external force vectors, that is,

$$\{\Delta d_i\} \equiv \{d_{i+1}\} - \{d_i\}, \quad \{\Delta v_i\} \equiv \{v_{i+1}\} - \{v_i\}, \quad \{\Delta a_i\} \equiv \{a_{i+1}\} - \{a_i\}, \quad \{\Delta p_i\} \equiv \{p_{i+1}\} - \{p_i\} \quad (5-6-2)$$

$\{\Delta f\}$ is the unbalanced force vector in the previous step. Using the Newmark- β method,

$$\{\Delta v_i\} = \{a_i\}(\Delta t) + \frac{1}{2}\{\Delta a_i\}(\Delta t) \quad (5-6-3)$$

$$\{\Delta d_i\} = \{v_i\}(\Delta t) + \frac{1}{2}\{a_i\}(\Delta t)^2 + \beta\{\Delta a_i\}(\Delta t)^2 \quad (5-6-4)$$

From Equation (5-6-4), we obtain

$$\{\Delta a_i\} = \frac{1}{\beta(\Delta t)^2}\{\Delta d_i\} - \frac{1}{\beta(\Delta t)}\{v_i\} - \frac{1}{2\beta}\{a_i\} \quad (5-6-5)$$

Substituting Equation (5-6-4) into Equation (5-6-3) gives

$$\{\Delta v_i\} = \frac{1}{2\beta(\Delta t)}\{\Delta d_i\} - \frac{1}{2\beta}\{v_i\} + \left(1 - \frac{1}{4\beta}\right)\{a_i\}(\Delta t) \quad (5-6-6)$$

Equations (5-6-5) and (5-6-6) are substituted into the equation of motion, Equation (5-6-2), and we obtain

$$\begin{aligned} & \{\Delta d_i\} \left[\frac{1}{\beta(\Delta t)^2}[M] + \frac{1}{2\beta(\Delta t)}[C] + [K] \right] \\ & = \{\Delta p_i\} + [M] \left[\frac{1}{\beta(\Delta t)}\{v_i\} + \frac{1}{2\beta}\{a_i\} \right] + [C] \left[\frac{1}{2\beta}\{v_i\} + \left(\frac{1}{4\beta} - 1 \right) \{a_i\}(\Delta t) \right] + \{\Delta f\} \end{aligned} \quad (5-6-7)$$

The equation can be rewritten as,

$$[\hat{K}] \cdot \{\Delta d_i\} = \{\Delta \hat{p}_i\} \quad (5-6-8)$$

where,

$$[\hat{K}] = [K] + \frac{1}{2\beta(\Delta t)}[C] + \frac{1}{\beta(\Delta t)^2}[M] \quad (5-6-9)$$

$$\{\Delta \hat{p}_i\} = \{\Delta p_i\} + [M] \left(\frac{1}{\beta(\Delta t)} \{v_i\} + \frac{1}{2\beta} \{a_i\} \right) + [C] \left[\frac{1}{2\beta} \{v_i\} + \left(\frac{1}{4\beta} - 1 \right) \{a_i\} (\Delta t) \right] + \{\Delta f\} \quad (5-6-10)$$

b) Force correction method

The equation of motion of a structural system is,

$$[M]\{a_{n+1}\} + [C]\{v_{n+1}\} + \{f_n\} - \{\Delta f\} + [K](\{d_{n+1}\} - \{d_n\}) = \{P_{n+1}\} \quad (5-6-11)$$

where, $[M]$, $[C]$ and $[K]$ are the mass, damping and stiffness matrices. $\{d_{n+1}\}$, $\{v_{n+1}\}$ and $\{a_{n+1}\}$ are the displacement, velocity and acceleration vector at time step (n+1). $\{f_n\}$ is the restoring force vector corresponding to $\{d_n\}$, and $\{\Delta f\}$ is the unbalanced force vector in the previous step. $\{P_{n+1}\}$ is the external force vector.

Using the average acceleration method,

$$\{d_{n+1}\} = \{d_n\} + \{v_n\}(\Delta t) + \frac{1}{4}(\{a_n\} + \{a_{n+1}\})(\Delta t)^2 \quad (5-6-12)$$

$$\{v_{n+1}\} = \{v_n\} + \frac{1}{2}(\{a_n\} + \{a_{n+1}\})(\Delta t) \quad (5-6-13)$$

Substituting Equations (6-2-2) and (6-2-3) into (6-2-1),

$$[M]\{a_{n+1}\} + [C] \left(\{v_n\} + \frac{1}{2}(\{a_n\} + \{a_{n+1}\})(\Delta t) \right) + \{f_n\} - \{\Delta f\} + [K] \left(\{v_n\}(\Delta t) + \frac{1}{4}(\{a_n\} + \{a_{n+1}\})(\Delta t)^2 \right) = \{P_{n+1}\} \quad (5-6-14)$$

Solving for $\{a_{n+1}\}$,

$$[L]\{a_{n+1}\} = [F_n] \quad (5-6-15)$$

where

$$[L] = [M] + \frac{1}{2}[C](\Delta t) + \frac{1}{4}[K](\Delta t)^2 \quad (5-2-16)$$

$$[F_n] = -[C] \left(\{v_n\} + \frac{1}{2}\{a_n\}(\Delta t) \right) - \{f_n\} + \{\Delta f\} - [K] \left(\{v_n\}(\Delta t) + \frac{1}{4}\{a_n\}(\Delta t)^2 \right) + \{P_{n+1}\} \quad (5-6-17)$$

$$[M]\{a_{n+1}\} + [C]\{v_{n+1}\} + \{f_{n+1}\} = \{P_{n+1}\}$$

from the following Figure,

$$\{f_{n+1}\} = \{f_n\} + [K](\{d_{n+1}\} - \{d_n\}) - \{\Delta f\}$$

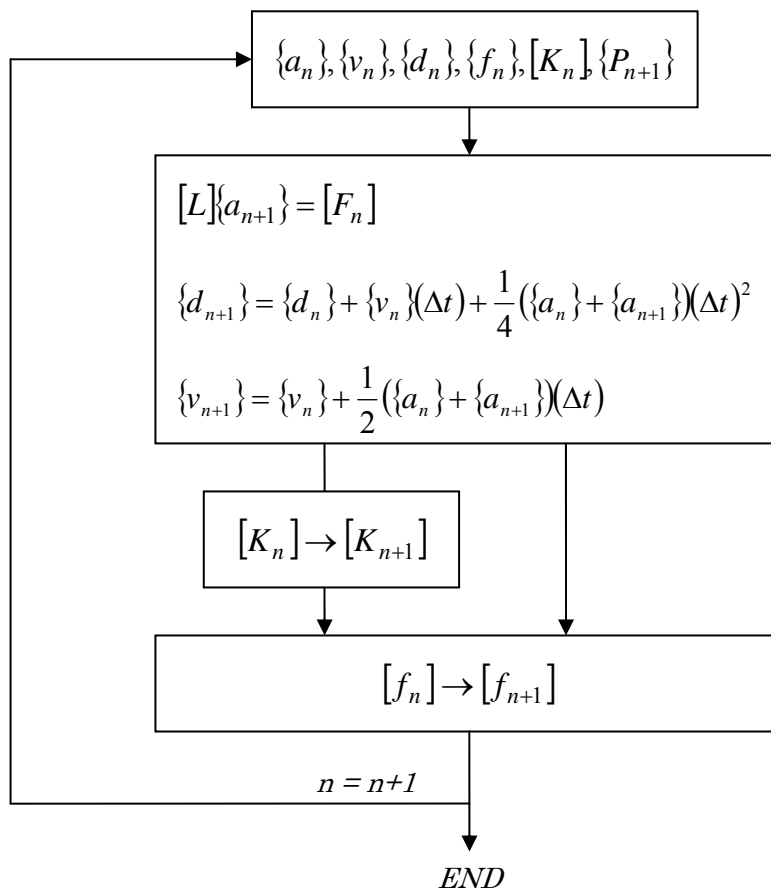
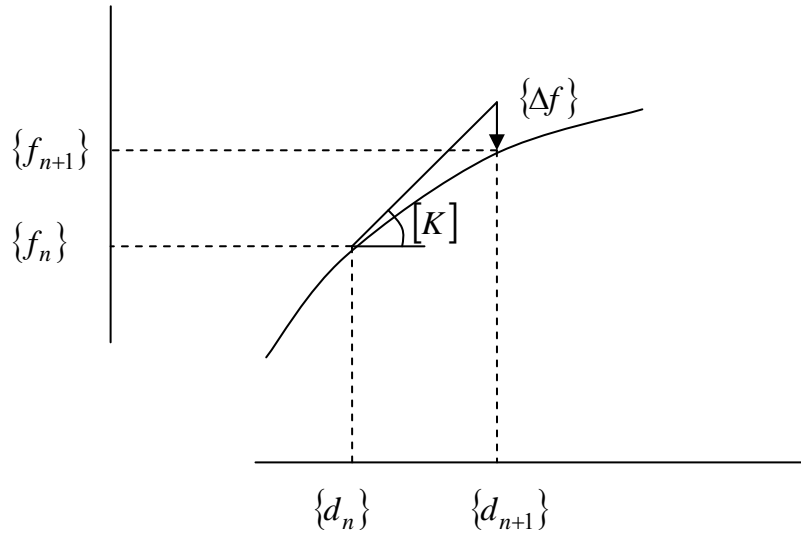

5.7 Energy

a) Equation of energy

As it was mentioned in Equation (5-5-2), the equation of motion is obtained as:

$$[M]\{\ddot{u}\} + [C]\{\dot{u}\} + [K]\{u\} = -[M][U] \begin{Bmatrix} \ddot{X}_0 \\ \ddot{Y}_0 \\ \ddot{Z}_0 \end{Bmatrix} = \{P\} \quad (5-7-1)$$

For example, in case of a structure with a rigid floor in Figure 5-7-1, the displacement vector, $\{u\}$, consists of 15 components (see RED numbers in Figure 5-7-1.)

$$\{u\} = \begin{Bmatrix} u_1 \\ u_2 \\ \vdots \\ u_{15} \end{Bmatrix} \quad (5-7-2)$$

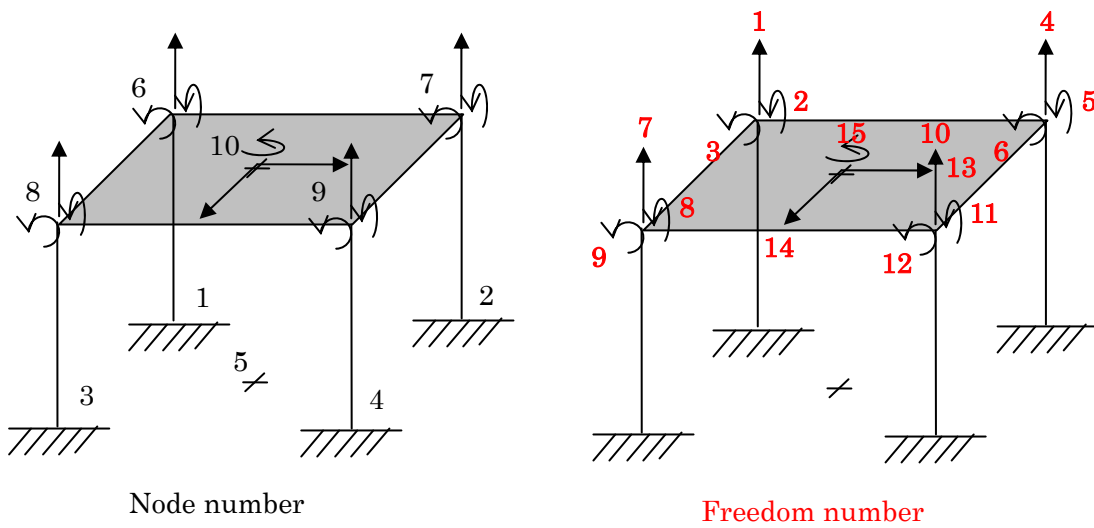

Figure 5-7-1 Example of the freedom vector of a structure with a rigid floor

The equation of energy is derived by multiplying the velocity vector, $\{\dot{u}\}^T$, and integrating by the time range $[0-t]$:

$$\int_0^t \{\dot{u}\}^T [M] \{\ddot{u}\} dt + \int_0^t \{\dot{u}\}^T [C] \{\dot{u}\} dt + \int_0^t \{\dot{u}\}^T [K] \{u\} dt = - \int_0^t \{\dot{u}\}^T \{P\} dt \quad (5-7-3)$$

$$\frac{\{\dot{u}\}^T [M] \{\dot{u}\}}{2} + \int_0^t \{\dot{u}\}^T [C] \{\dot{u}\} dt + \frac{\{u\}^T [K] \{u\}}{2} = - \int_0^t \{\dot{u}\}^T \{P\} dt \quad (5-7-4)$$

$$W_K + W_D + W_P = W_I \quad (5-7-5)$$

where,

$$W_K = \frac{\{\dot{u}\}^T [M] \{\dot{u}\}}{2} \quad : \text{Kinematic energy}$$

$$W_D = \int_0^t \{\dot{u}\}^T [C] \{\dot{u}\} dt \quad : \text{Damping energy}$$

$$W_P = \frac{\{u\}^T [K] \{u\}}{2} \quad : \text{Potential energy}$$

$$W_I = - \int_0^t \{\dot{u}\}^T \{P\} dt \quad : \text{Input energy}$$

If the system is nonlinear, the equation of motion can be expressed as:

$$[M] \{\ddot{u}\} + [C] \{\dot{u}\} + Q(u, \dot{u}) = - [M] [U] \begin{Bmatrix} \ddot{X}_0 \\ \ddot{Y}_0 \\ \ddot{Z}_0 \end{Bmatrix} = \{P\} \quad (5-7-6)$$

where, $Q(u, \dot{u})$ is the nonlinear restoring force vector. Then, the equation of energy can be derived as;

$$W_K + W_D + W_P = W_I \quad (5-7-7)$$

where,

$$W_K = \frac{\{\dot{u}\}^T [M] \{\dot{u}\}}{2} \quad : \text{Kinematic energy}$$

$$W_D = \int_0^t \{\dot{u}\}^T [C] \{\dot{u}\} dt \quad : \text{Damping energy}$$

$$W_P = \int_0^t \{\dot{u}\}^T Q(u, \dot{u}) dt \quad : \text{Potential energy} \quad (5-7-8)$$

$$W_I = - \int_0^t \{\dot{u}\}^T \{P\} dt \quad : \text{Input energy}$$

b) Decomposition of potential energy

We can decompose the restoring force vector into the restoring force of each member as,

$$Q(u, \dot{u}) = q_1(u, \dot{u}) + q_2(u, \dot{u}) + \cdots + q_n(u, \dot{u}); \quad n : \text{number of members} \quad (5-7-9)$$

Therefore, the potential energy can be decomposed as,

$$W_P = \int_0^t \{\dot{u}\}^T Q(u, \dot{u}) dt = \int_0^t \{\dot{u}\}^T \sum_{i=1}^n q_i(u, \dot{u}) dt = \sum_{i=1}^n \left(\int_0^t \{\dot{u}\}^T q_i(u, \dot{u}) dt \right) = \sum_{i=1}^n W_{P,i} \quad (5-7-10)$$

where

$$W_{P,i} = \int_0^t \{\dot{u}\}^T q_i(u, \dot{u}) dt; \quad \text{potential energy of } i\text{-th member} \quad (5-7-11)$$

6. Nonlinear Static Push-Over Analysis

6.1 Lateral distribution of earthquake force

The static lateral load representing the earthquake force is applied at the center of gravity in each floor. There are several formulas to define the load distribution along the height of the building. In “STERA 3D” program, the following distributions are prepared:

1. Ai 2. Triangular 3. Uniform 4. UBC 5. Mode

(1) Ai distribution

In the “Building Standard Law” in Japan, the design shear force of i-th story, Q_i , is defined as,

$$Q_i = C_i \sum_{j=i}^n w_j, \quad C_i = ZR_i A_i C_0 \quad (6-1-1)$$

where,

- C_i : design shear coefficient of i-th story,
- w_i : weight of i-th story,
- Z : seismic zone factor,
- R_i : vibration characteristic factor taking into consideration of soil condition,
- A_i : lateral distribution of shear force coefficient,
- C_0 : design base shear coefficient ($C_0=0.2$ for serviceability limit, $C_0=1.0$ for safety limit)

If we set, $Z=1.0$ (Tokyo), $R_i=1.0$ (stiff soil, a short story building), $C_0=1.0$ (safety design), the design shear force distribution is simplified as,

$$Q_i = A_i \sum_{j=i}^n w_j \quad (6-1-2)$$

“ A_i ” distribution is defined as,

$$A_i = 1 + \left(\frac{1}{\sqrt{\alpha_i}} - \alpha_i \right) \frac{2T}{1+3T} \quad (6-1-3)$$

where,

$$\alpha_i = \sum_{j=i}^n w_j / W, \quad W = \sum_{j=1}^n w_j : \text{the ratio of weight upper than i-th story,}$$

T : the first natural period of a building ($=0.02h$, h : the building height)

As shown in Figure 6-1-1, the static lateral load is obtained as,

$$F_n = Q_n, \quad F_i = Q_i - Q_{i+1} \quad (i = 1, \dots, n-1) \quad (6-1-4)$$

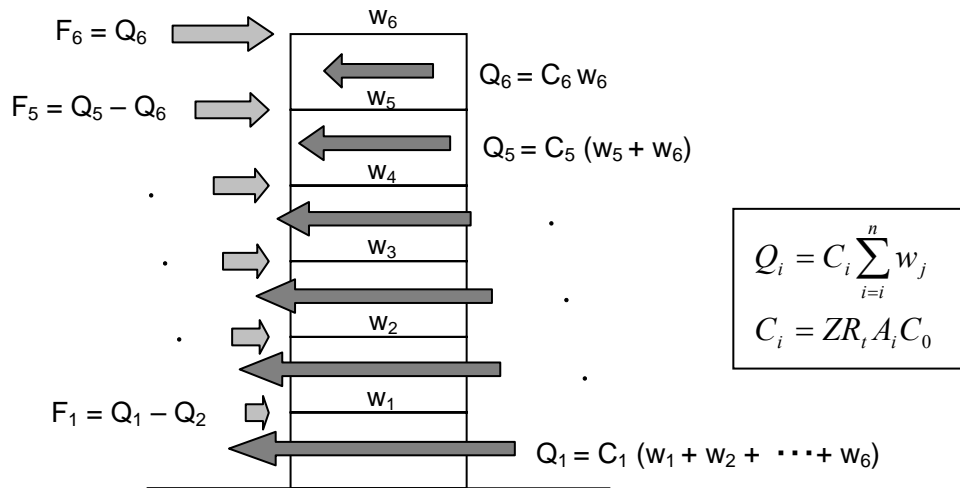

Figure 6-1-1 Ai distribution

(2) Triangular distribution

Triangular distribution is defined as:

$$F_i = Q_B \left(\frac{h_i}{\sum_{j=1}^n h_j} \right) \tag{6-1-5}$$

where,

- Q_B : base shear force
- h_i : the height of the i-th story from the ground

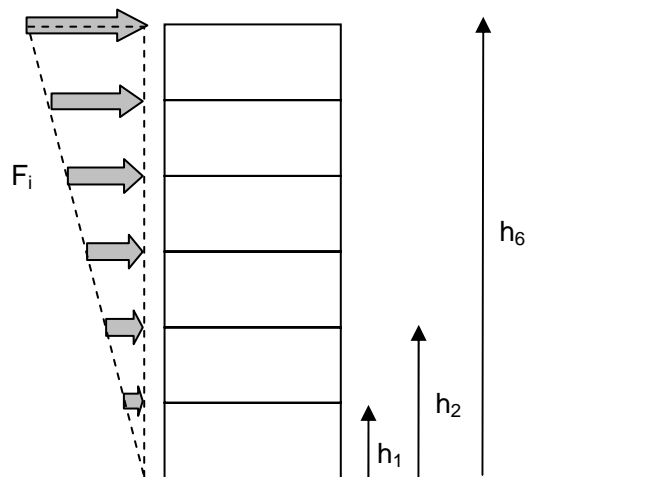

Figure 6-1-2 Triangular distribution

(3) Uniform distribution

Uniform distribution is defined as:

$$F_i = Q_B (1/n) \tag{6-1-6}$$

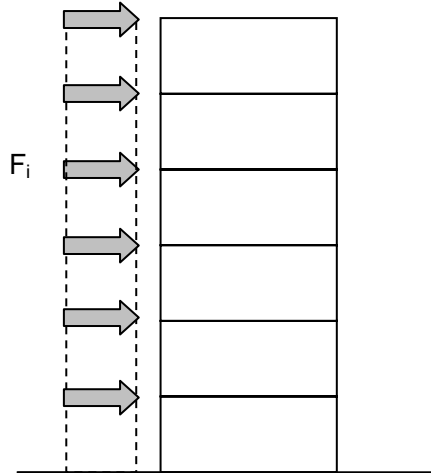

Figure 6-1-3 Uniform distribution

(4) UBC distribution

The UBC (Uniform Building Code, 1997) gives the following formula for the calculation of lateral force distribution:

$$F_i = (Q_B - F_t) \left(w_i h_i / \sum_{j=1}^n w_j h_j \right) \tag{6-1-7}$$

$$F_t = \begin{cases} 0.07 T Q_B, & \text{if } T > 0.7 \text{ sec} \\ 0, & \text{if } T \leq 0.7 \text{ sec} \end{cases} \tag{6-1-8}$$

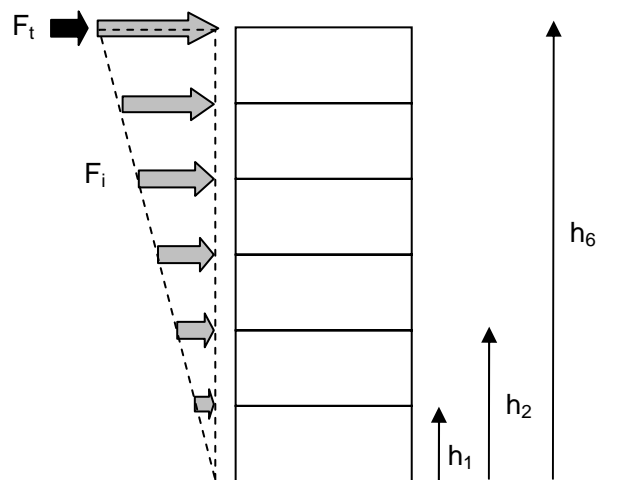

Figure 6-1-4 UBC distribution

(4) Mode distribution

Mode distribution is defined as:

$$F_i = Q_B \left(w_i \phi_{1,i} / \sum_{j=1}^n w_j \phi_{1,j} \right) \tag{6-1-9}$$

where,

$\phi_{1,i}$: component of the first mode distribution in the i-th story

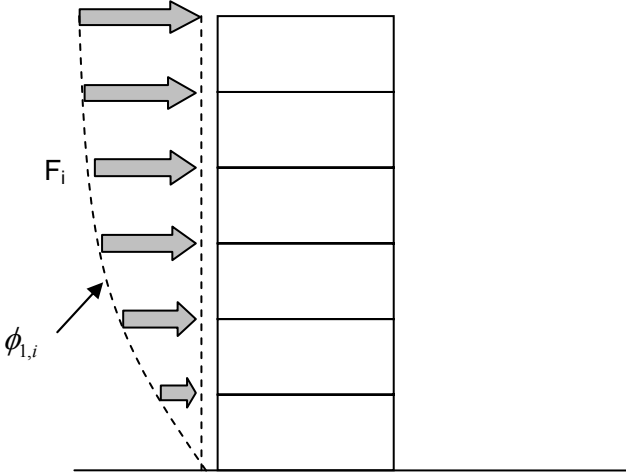

Figure 6-1-5 Mode distribution

6.2 Capacity Curve

The **Capacity Spectrum Method** was proposed by Freeman [1978] as an approximate way to estimate the maximum response of a structure under an earthquake ground motion. The concept was modified by Kuramoto et.al [2000] to adopt the distribution of nonlinear story displacement as the first mode shape in each calculation step. The method was adopted as one of the evaluation procedures in the Building Standard Law, Japan.

The key concept of the Capacity Spectrum Method is to find out the intersection between the **Demand Spectra** (= relationship between S_d (displacement spectra) and S_a (acceleration spectra)) and the **Capacity Curve** (= nonlinear push-over curve of an equivalent single-degree-of-freedom system).

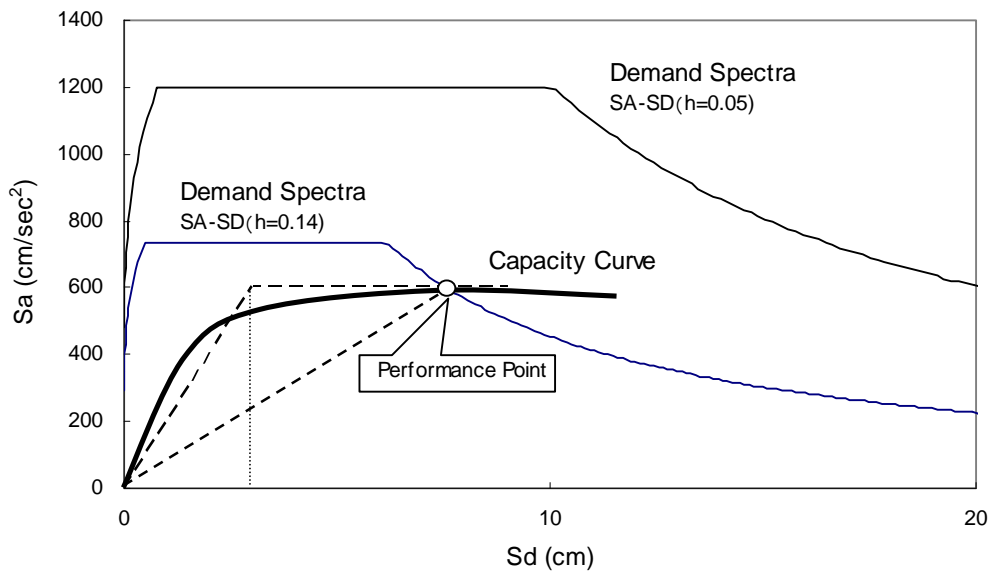

Figure 6-2-1 Schematic example of the concept of Capacity Spectrum Method

“STERA 3D” provides the menu in the static analysis to show the Capacity Curve based on the following formula (Kuramoto et.al [2000]):

$$S_a = Q_B \frac{\sum_{i=1}^n m_i \delta_i^2}{\left(\sum_{i=1}^n m_i \delta_i \right)^2}, \quad S_d = \frac{\sum_{i=1}^n m_i \delta_i^2}{\sum_{i=1}^n m_i \delta_i} \quad (6-2-1)$$

where,

- m_i : lumped mass in the i -th story
- δ_i : component of the distribution of nonlinear story displacement in the i -th story

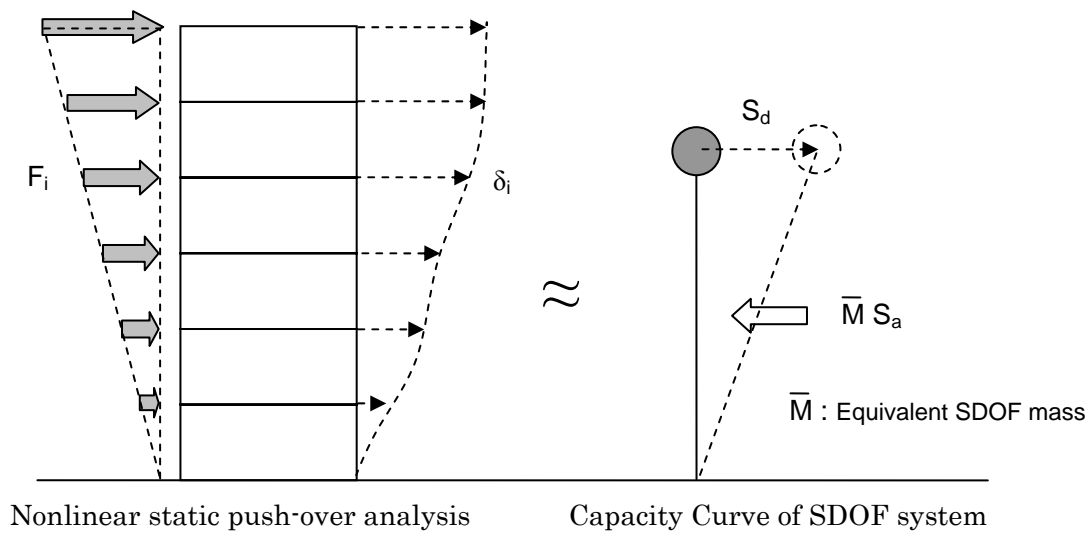

Figure 8-2-2 Capacity Curve of the equivalent SDOF system

As schematically shown in Figure 8-2-2, the step-by-step results of nonlinear push-over analysis is used to obtain the Capacity Curve of the equivalent SDOF system using Equation (8-2-1).

References

Freeman S. A. (1978), "Prediction of Response of Concrete Buildings to Severe Earthquake Motion", Douglas McHenry International Symposium on Concrete and Concrete Structures, SP-55, American Concrete Institute, Detroit, Michigan, pp. 589-605.

Kuramoto H., et.al. (200), "Predicting the Earthquake Response of Buildings using Equivalent Single Degree of Freedom System", 12th World Conference on Earthquake Engineering (12WCEE), Auckland New Zealand, 2000.2.

7. Others

7.1 Decomposition of shear and flexural deformation

a) Equivalent plane for each floor

The equivalent plane ($z = ax + by + c$) is obtained from the vertical displacement distribution by the least square method:

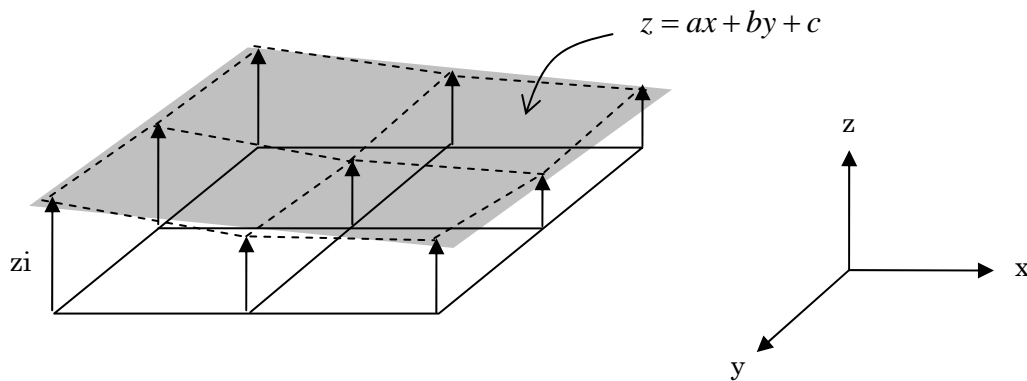

Figure 7-1-1 Equivalent plane

Minimize
$$L = \sum (z_i - (ax_i + by_i + c))^2$$

where, i : node number in the floor

a, b, c : parameters of equivalent plane

Thus,
$$\frac{\partial L}{\partial a} = 0, \quad \frac{\partial L}{\partial b} = 0, \quad \frac{\partial L}{\partial c} = 0$$

Parameters, a, b, c are obtained by solving the following linear equation:

$$\begin{bmatrix} \sum z_i x_i \\ \sum z_i y_i \\ \sum z_i \end{bmatrix} = \begin{bmatrix} \sum x_i^2 & \sum x_i y_i & \sum x_i \\ & \sum y_i^2 & \sum y_i \\ sym. & & n \end{bmatrix} \begin{bmatrix} a \\ b \\ c \end{bmatrix} \quad (7-1-1)$$

where,

n : the number of nodes in a floor

b) Decomposition of shear and flexural deformation

A story drift, D , can be divided into shear and flexural components as,

$$D = D_S \text{ (shear)} + D_F \text{ (flexure)} \quad (7-1-2)$$

Assuming the distribution of floor deformation is expressed by an equivalent plane ($z = ax + by + c$), the flexural deformation, D_F , can be expressed as,

$$D_F = -a H \quad : \text{ x-direction} \quad (7-1-3)$$

$$D_F = b H \quad : \text{ y-direction} \quad (7-1-4)$$

Note that the coefficient 'a' is the negative angle in x-direction.

Then, the shear deformation can be obtained as,

$$D_S = D - D_F \quad (7-1-5)$$

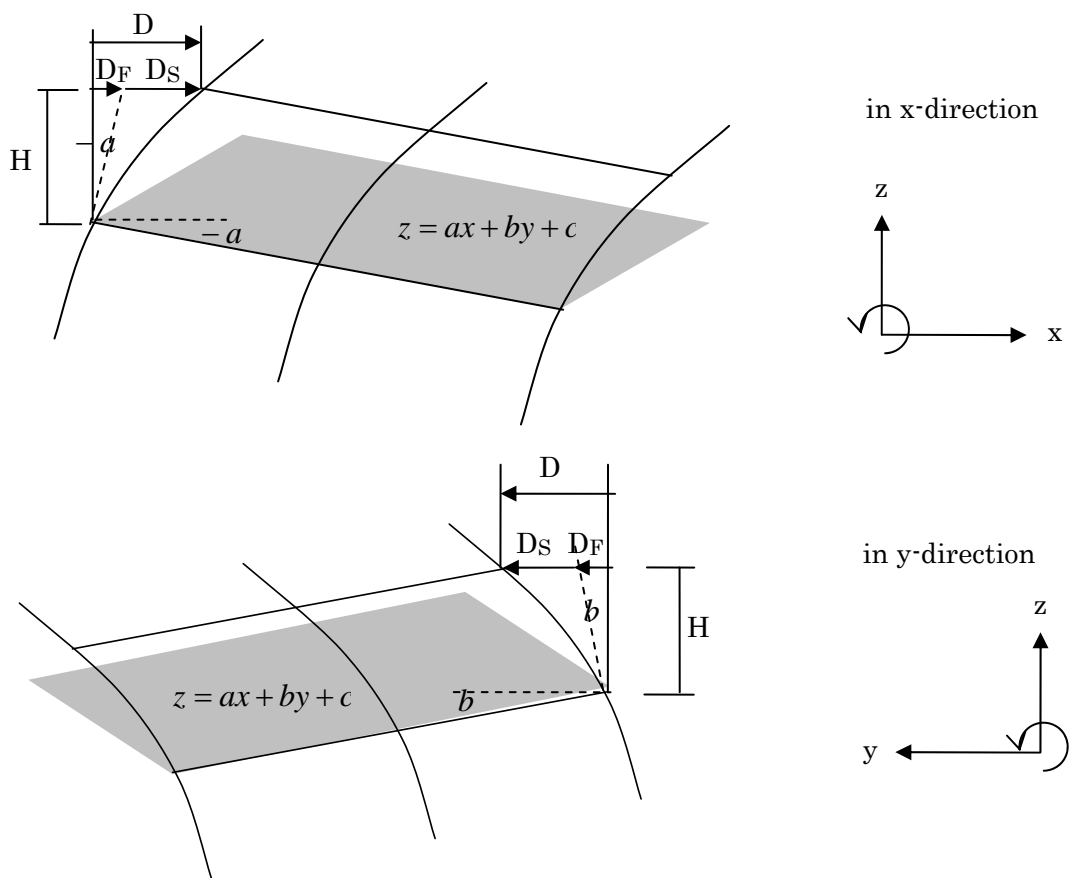

Figure 7-1-2 Decomposition of shear and flexural deformation

In STERA 3D, the flexural deformation is calculated taking the average of the bottom floor angle and top floor angle.

$$D_{Fi} = \frac{-(a_i + a_{i+1})}{2} H_i \quad : \text{ x-direction} \quad (7-1-6)$$

$$D_{Fi} = \frac{(b_i + b_{i+1})}{2} H_i \quad : \text{ y-direction} \quad (7-1-7)$$

7.2 P-D effect

Following formulation is suggested in the following book:

James F. Doyle, "Static and Dynamic Analysis of Structures", Kluwer Academic Publishers, 1991

a) Equilibrium of the beam with an axial load

We consider equilibrium of the beam with a slight displacement with an axial load.

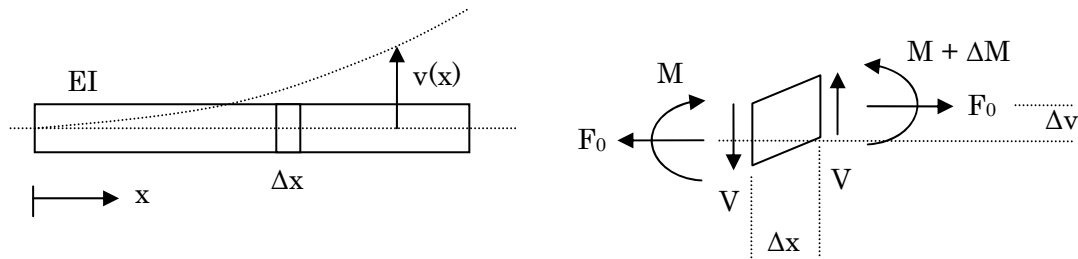

Figure 7-2-1 Equilibrium of small beam segment slightly deformed

Assuming small deflection, the balance of moment on the small segment "Δx" gives

$$\Delta M + V(\Delta x) - F_0(\Delta v) = 0 \quad (7-2-1)$$

Therefore

$$\frac{dM}{dx} + V - F_0 \frac{dv}{dx} = 0 \quad (7-2-2)$$

From the relationship, $M = EI \frac{d^2v}{dx^2}$, the governing differential equation for the deflection shape is

$$EI \frac{d^4v}{dx^4} - F_0 \frac{d^2v}{dx^2} = 0 \quad (7-2-3)$$

The general solutions are,

for compression loading ($F_0 < 0$):

$$v(x) = c_1 \cos kx + c_2 \sin kx + c_3 x + c_4, \quad k^2 = -F_0 / EI, \quad (7-2-4)$$

for tensile loading ($F_0 > 0$):

$$v(x) = c_1 \cosh kx + c_2 \sinh kx + c_3 x + c_4, \quad k^2 = F_0 / EI \quad (7-2-5)$$

b) Geometric stiffness matrix of the beam with an axial load

We assume that the axial force is constant and compressive. From the general solution, Eq. (7-2-4), at $x = 0$

$$v(0) = v_1 = c_1 + c_4, \quad \frac{dv(0)}{dx} = \phi_1 = kc_2 + c_3 \quad (7-2-6)$$

Consequently, the deflected shape is

$$v(x) = c_1(\cos kx - 1) + c_2(\sin kx - kx) + v_1 + \phi_1 x \quad (7-2-7)$$

Similarly at the end of other node,

$$v(L) = v_2 = c_1(\cos kL - 1) + c_2(\sin kL - kL) + v_1 + \phi_1 L \quad (7-2-8)$$

$$\frac{dv(L)}{dx} = \phi_2 = -kc_1 \sin kL + kc_2 \cos kL + \phi_1 \quad (7-2-9)$$

Then, the coefficients, c_1, c_2 , can be arranged as,

$$\begin{bmatrix} (1-C) & (\xi-S) \\ \xi S & \xi(1-C) \end{bmatrix} \begin{bmatrix} c_1 \\ c_2 \end{bmatrix} = \begin{bmatrix} v_1 + \phi_1 L - v_2 \\ \phi_1 L - \phi_2 L \end{bmatrix} \quad (7-2-10)$$

where,

$$C = \cos kL, \quad S = \sin kL, \quad \xi = kL \quad (7-2-11)$$

Solving this equation by Cramer's rule gives

$$c_1 = [v_1 \xi(1-C) + \phi_1 L(S - \xi C) - v_2 \xi(1-C) + \phi_2 L(\xi - S)] / \Delta \quad (7-2-12)$$

$$c_2 = [-v_1 \xi S + \phi_1 L(1-C - \xi S) + v_2 \xi S + \phi_2 L(C - 1)] / \Delta \quad (7-2-13)$$

where

$$\Delta = \xi(2 - 2C - \xi S) \quad (7-2-14)$$

Now we can rewrite the deflection function in terms of the nodal degrees of freedom. The moment and shear force distributions can be obtained as

$$M(x) = EI \frac{d^2 v}{dx^2} = EI[-k^2 c_1 \cos kx - k^2 c_2 \sin kx] \quad (7-2-15)$$

$$V(x) = -EI \frac{d^3 v}{dx^3} + F_0 \frac{dv}{dx} = -EI k^2 [\phi_1 - kc_2] \quad (7-2-16)$$

Calculating nodal loads, $V(0) = -V_1$, $M(0) = -M_1$, $V(L) = V_1$, $M(L) = M_1$, the stiffness matrix is

$$\begin{bmatrix} V_1 \\ M_1 \\ V_2 \\ M_2 \end{bmatrix} = \frac{EI \xi^2}{L^3 \Delta} \begin{bmatrix} \xi^2 S & \xi L(1-C) & -\xi^2 S & \xi L(1-C) \\ -L^2(\xi C - S) & -\xi L(1-C) & L^2(\xi - S) & \\ & \xi^2 S & -\xi L(1-C) & \\ sym. & & -L^2(\xi C - S) & \end{bmatrix} \begin{bmatrix} v_1 \\ \phi_1 \\ v_2 \\ \phi_2 \end{bmatrix} \quad (7-2-17)$$

c) Approximation of geometric stiffness matrix

We simplify the geometric stiffness matrix to be linear in the loading F_0 .

Using the series expansion for the sine and cosine terms, the determinant is,

$$\begin{aligned} \Delta &= \xi(2 - 2C - \xi S) \\ &\approx \xi \left[2 - 2 \left(1 - \frac{\xi^2}{2} + \frac{\xi^4}{24} - \frac{\xi^6}{720} + \dots \right) C - \xi \left(\xi - \frac{\xi^3}{6} + \frac{\xi^5}{120} - \dots \right) \right] \\ &\approx \xi^5 \left[1 - \frac{\xi^2}{15} + \dots \right] / 12 \end{aligned} \quad (7-2-18)$$

also

$$\frac{1}{\Delta} = \frac{12}{\xi^5} \left[1 + \frac{\xi^2}{15} + \dots \right] \quad (7-2-19)$$

We now do the expansion on the stiffness terms. For example,

$$k_{11} = \frac{EI \xi^2}{L^3 \Delta} (\xi^2 S) = \frac{EI}{L^3} \left[\xi^4 \left(\xi - \frac{\xi^3}{6} + \dots \right) \right] \frac{12}{\xi^5} \left[1 + \frac{\xi^2}{15} + \dots \right] = \frac{EI}{L^3} 12 \left[1 - \frac{\xi^2}{10} + \dots \right] \quad (7-2-20)$$

Substituting $\xi^2 = k^2 L^2 = -F_0 L / EI$,

$$k_{11} = \frac{EI}{L^3} [12] + \frac{F_0}{L} \left[\frac{12}{10} \right] \quad (7-2-21)$$

In the same manner, we can expand for all the stiffness terms to get the stiffness matrix as

$$[k] = \frac{EI}{L^3} \begin{bmatrix} 12 & 6L & -12 & 6L \\ & 4L^2 & -6L & 2L^2 \\ & & 12 & -6L \\ sym. & & & 4L^2 \end{bmatrix} + \frac{F_0}{30L} \begin{bmatrix} 36 & 3L & -36 & 3L \\ & 4L^2 & -3L & -L^2 \\ & & 36 & -3L \\ sym. & & & 4L^2 \end{bmatrix} \quad (7-2-22)$$

We can write as

$$[k] = [k_E] + [k_G] \quad (7-2-23)$$

where, $[k_E]$: the element elastic stiffness, $[k_G]$: the element geometric stiffness

d) Implementation for beam element

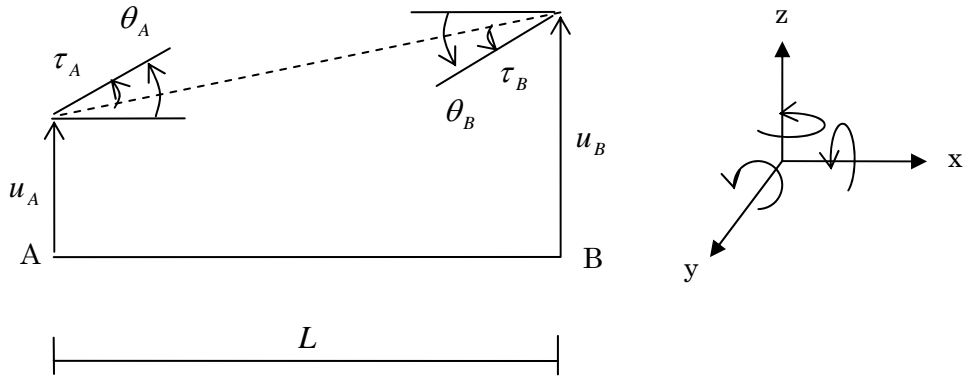

Figure 7-2-2 Including node movement

For beam element,

$$\begin{bmatrix} M_A \\ M_B \end{bmatrix} = \frac{2EI}{L} \begin{bmatrix} 2 & 1 \\ 1 & 2 \end{bmatrix} \begin{bmatrix} \tau_A \\ \tau_B \end{bmatrix} = \frac{EI}{L^3} \begin{bmatrix} 4L^2 & 2L^2 \\ 2L^2 & 4L^2 \end{bmatrix} \begin{bmatrix} \tau_A \\ \tau_B \end{bmatrix} \quad (7-2-24)$$

Including node movement,

$$\begin{bmatrix} \tau_A \\ \tau_B \end{bmatrix} = \begin{bmatrix} \frac{1}{L} & 1 & -\frac{1}{L} & 0 \\ \frac{1}{L} & 0 & -\frac{1}{L} & 1 \end{bmatrix} \begin{bmatrix} u_A \\ \theta_A \\ u_B \\ \theta_B \end{bmatrix} \quad (7-2-25)$$

$$\begin{aligned} \begin{bmatrix} Q_A \\ M_A \\ Q_B \\ M_B \end{bmatrix} &= \frac{EI}{L^3} \begin{bmatrix} \frac{1}{L} & \frac{1}{L} \\ 1 & 0 \\ -\frac{1}{L} & -\frac{1}{L} \\ 0 & 1 \end{bmatrix} \begin{bmatrix} 4L^2 & 2L^2 \\ 2L^2 & 4L^2 \end{bmatrix} \begin{bmatrix} \frac{1}{L} & 1 & -\frac{1}{L} & 0 \\ \frac{1}{L} & 0 & -\frac{1}{L} & 1 \end{bmatrix} \begin{bmatrix} u_A \\ \theta_A \\ u_B \\ \theta_B \end{bmatrix} \\ &= \frac{EI}{L^3} \begin{bmatrix} 6L & 6L \\ 4L^2 & 2L^2 \\ -6L & -6L \\ 2L^2 & 4L^2 \end{bmatrix} \begin{bmatrix} \frac{1}{L} & 1 & -\frac{1}{L} & 0 \\ \frac{1}{L} & 0 & -\frac{1}{L} & 1 \end{bmatrix} \begin{bmatrix} u_A \\ \theta_A \\ u_B \\ \theta_B \end{bmatrix} = \frac{EI}{L^3} \begin{bmatrix} 12 & 6L & -12 & 6L \\ & 4L^2 & -6L & 2L^2 \\ & & 12 & -6L \\ \text{sym.} & & & 4L^2 \end{bmatrix} \begin{bmatrix} u_A \\ \theta_A \\ u_B \\ \theta_B \end{bmatrix} \end{aligned}$$

From (7-2-22), the geometric stiffness matrix will be

$$[k_G] = \frac{F_0}{30L} \begin{bmatrix} 36 & 3L & -36 & 3L \\ & 4L^2 & -3L & -L^2 \\ & & 36 & -3L \\ \text{sym.} & & & 4L^2 \end{bmatrix} \quad (7-2-26)$$

e) Implementation for column element

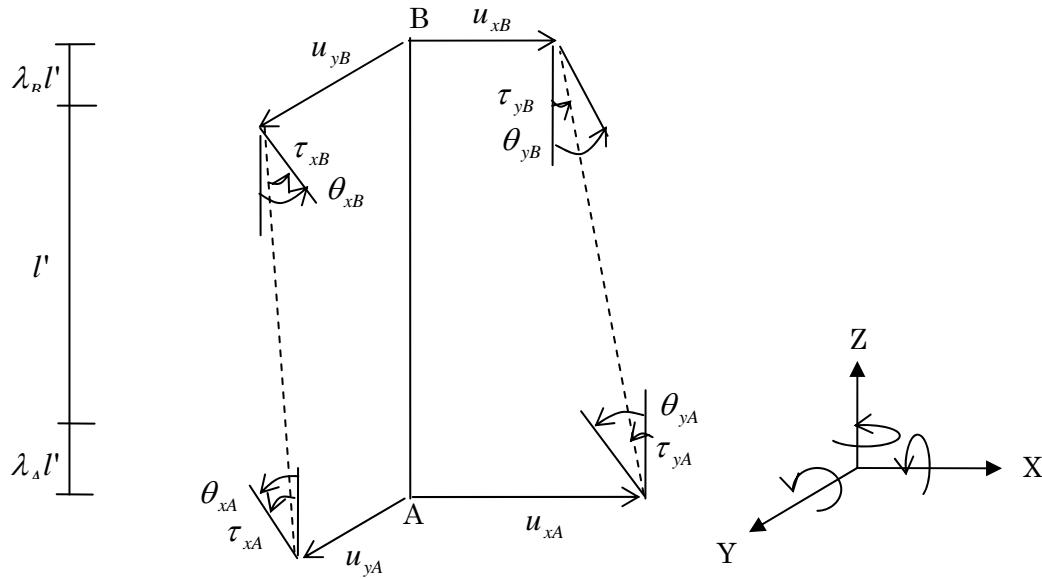

Figure 7-2-3 Including node movement

$$\begin{bmatrix} M_{yA} \\ M_{yB} \end{bmatrix} = \frac{2EI}{L} \begin{bmatrix} 2 & 1 \\ 1 & 2 \end{bmatrix} \begin{bmatrix} \tau_{yA} \\ \tau_{yB} \end{bmatrix} = \frac{EI}{L^3} \begin{bmatrix} 4L^2 & 2L^2 \\ 2L^2 & 4L^2 \end{bmatrix} \begin{bmatrix} \tau_{yA} \\ \tau_{yB} \end{bmatrix} \quad \text{in X-Z plane} \quad (7-2-27)$$

$$\begin{bmatrix} M_{xA} \\ M_{xB} \end{bmatrix} = \frac{2EI}{L} \begin{bmatrix} 2 & 1 \\ 1 & 2 \end{bmatrix} \begin{bmatrix} \tau_{xA} \\ \tau_{xB} \end{bmatrix} = \frac{EI}{L^3} \begin{bmatrix} 4L^2 & 2L^2 \\ 2L^2 & 4L^2 \end{bmatrix} \begin{bmatrix} \tau_{xA} \\ \tau_{xB} \end{bmatrix} \quad \text{in Y-Z plane} \quad (7-2-28)$$

Including node movement,

$$\begin{bmatrix} \tau_{yA} \\ \tau_{yB} \end{bmatrix} = \begin{bmatrix} -\frac{1}{L} & 1 & \frac{1}{L} & 0 \\ -\frac{1}{L} & 0 & \frac{1}{L} & 1 \end{bmatrix} \begin{bmatrix} u_{xA} \\ \theta_{yA} \\ u_{xB} \\ \theta_{yB} \end{bmatrix} \quad \text{in X-Z plane} \quad (7-2-29)$$

$$\begin{bmatrix} \tau_{xA} \\ \tau_{xB} \end{bmatrix} = \begin{bmatrix} \frac{1}{L} & 1 & -\frac{1}{L} & 0 \\ \frac{1}{L} & 0 & -\frac{1}{L} & 1 \end{bmatrix} \begin{bmatrix} u_{yA} \\ \theta_{xA} \\ u_{yB} \\ \theta_{xB} \end{bmatrix} \quad \text{in Y-Z plane} \quad (7-2-30)$$

Note that the matrix for node movement in X-Z plane is different from that of beam element. The force-deformation relationship in X-Z plane is then,

$$\begin{aligned}
\begin{Bmatrix} Q_{xA} \\ M_{yA} \\ Q_{xB} \\ M_{yB} \end{Bmatrix} &= \frac{EI}{L^3} \begin{bmatrix} -\frac{1}{L} & -\frac{1}{L} \\ 1 & 0 \\ \frac{1}{L} & \frac{1}{L} \\ 0 & 1 \end{bmatrix} \begin{bmatrix} 4L^2 & 2L^2 \\ 2L^2 & 4L^2 \end{bmatrix} \begin{bmatrix} -\frac{1}{L} & 1 & \frac{1}{L} & 0 \\ \frac{1}{L} & 0 & \frac{1}{L} & 1 \end{bmatrix} \begin{Bmatrix} u_{xA} \\ \theta_{yA} \\ u_{xB} \\ \theta_{yB} \end{Bmatrix} \\
&= \frac{EI}{L^3} \begin{bmatrix} -6L & -6L \\ 4L^2 & 2L^2 \\ 6L & 6L \\ 2L^2 & 4L^2 \end{bmatrix} \begin{bmatrix} -\frac{1}{L} & 1 & \frac{1}{L} & 0 \\ \frac{1}{L} & 0 & \frac{1}{L} & 1 \end{bmatrix} \begin{Bmatrix} u_{xA} \\ \theta_{yA} \\ u_{xB} \\ \theta_{yB} \end{Bmatrix} = \frac{EI}{L^3} \begin{bmatrix} 12 & -6L & -12 & -6L \\ & 4L^2 & 6L & 2L^2 \\ & & 12 & 6L \\ \text{sym.} & & & 4L^2 \end{bmatrix} \begin{Bmatrix} u_{xA} \\ \theta_{yA} \\ u_{xB} \\ \theta_{yB} \end{Bmatrix}
\end{aligned} \tag{7-2-31}$$

Considering the difference of sign of stiffness matrix in X-Z plane, the geometric stiffness matrix will be

$$[k_{xG}] = \frac{F_0}{30L} \begin{bmatrix} 36 & -3L & -36 & -3L \\ & 4L^2 & 3L & -L^2 \\ \text{sym.} & & 36 & 3L \\ & & & 4L^2 \end{bmatrix} \text{ in X-Z plane} \tag{7-2-32}$$

$$[k_{yG}] = \frac{F_0}{30L} \begin{bmatrix} 36 & 3L & -36 & 3L \\ & 4L^2 & -3L & -L^2 \\ \text{sym.} & & 36 & -3L \\ & & & 4L^2 \end{bmatrix} \text{ in Y-Z plane} \tag{7-2-33}$$

Therefore, changing the order of vector component, the force-deformation relationship of column will be

$$\begin{Bmatrix} Q_{xA} \\ Q_{xB} \\ M_{yA} \\ M_{yB} \\ Q_{yA} \\ Q_{yB} \\ M_{xA} \\ M_{xB} \\ N_{zA} \\ N_{zB} \\ M_{zA} \\ M_{zB} \end{Bmatrix} = [K] \begin{Bmatrix} u_{xA} \\ u_{xB} \\ \theta_{yA} \\ \theta_{yB} \\ u_{yA} \\ u_{yB} \\ \theta_{xA} \\ \theta_{xB} \\ \delta_{zA} \\ \delta_{zB} \\ \theta_{zA} \\ \theta_{zB} \end{Bmatrix} + \frac{F_0}{30L} \begin{bmatrix} 36 & -36 & -3L & -3L & 0 & 0 & 0 & 0 & 0 & 0 & 0 & 0 \\ -36 & 36 & 3L & 3L & 0 & 0 & 0 & 0 & 0 & 0 & 0 & 0 \\ -3L & 3L & 4L^2 & -L^2 & 0 & 0 & 0 & 0 & 0 & 0 & 0 & 0 \\ -3L & 3L & -L^2 & 4L^2 & 0 & 0 & 0 & 0 & 0 & 0 & 0 & 0 \\ 0 & 0 & 0 & 0 & 36 & -36 & 3L & 3L & 0 & 0 & 0 & 0 \\ 0 & 0 & 0 & 0 & -36 & 36 & -3L & -3L & 0 & 0 & 0 & 0 \\ 0 & 0 & 0 & 0 & 3L & -3L & 4L^2 & -L^2 & 0 & 0 & 0 & 0 \\ 0 & 0 & 0 & 0 & 3L & -3L & -L^2 & 4L^2 & 0 & 0 & 0 & 0 \\ 0 & 0 & 0 & 0 & 0 & 0 & 0 & 0 & 0 & 0 & 0 & 0 \\ 0 & 0 & 0 & 0 & 0 & 0 & 0 & 0 & 0 & 0 & 0 & 0 \\ 0 & 0 & 0 & 0 & 0 & 0 & 0 & 0 & 0 & 0 & 0 & 0 \end{bmatrix} \begin{Bmatrix} u_{xA} \\ u_{xB} \\ \theta_{yA} \\ \theta_{yB} \\ u_{yA} \\ u_{yB} \\ \theta_{xA} \\ \theta_{xB} \\ \delta_{zA} \\ \delta_{zB} \\ \theta_{zA} \\ \theta_{zB} \end{Bmatrix}$$

$$= \left[[K] + [K_G] \right] \begin{Bmatrix} u_{xA} \\ u_{xB} \\ \theta_{yA} \\ \theta_{yB} \\ u_{yA} \\ u_{yB} \\ \theta_{xA} \\ \theta_{xB} \\ \delta_{zA} \\ \delta_{zB} \\ \theta_{zA} \\ \theta_{zB} \end{Bmatrix} \quad (7-2-34)$$

where,

$$[K_G] = \frac{F_0}{30L} \begin{bmatrix} 36 & -36 & -3L & -3L & 0 & 0 & 0 & 0 & 0 & 0 & 0 & 0 \\ -36 & 36 & 3L & 3L & 0 & 0 & 0 & 0 & 0 & 0 & 0 & 0 \\ -3L & 3L & 4L^2 & -L^2 & 0 & 0 & 0 & 0 & 0 & 0 & 0 & 0 \\ -3L & 3L & -L^2 & 4L^2 & 0 & 0 & 0 & 0 & 0 & 0 & 0 & 0 \\ 0 & 0 & 0 & 0 & 36 & -36 & 3L & 3L & 0 & 0 & 0 & 0 \\ 0 & 0 & 0 & 0 & -36 & 36 & -3L & -3L & 0 & 0 & 0 & 0 \\ 0 & 0 & 0 & 0 & 3L & -3L & 4L^2 & -L^2 & 0 & 0 & 0 & 0 \\ 0 & 0 & 0 & 0 & 3L & -3L & -L^2 & 4L^2 & 0 & 0 & 0 & 0 \\ 0 & 0 & 0 & 0 & 0 & 0 & 0 & 0 & 0 & 0 & 0 & 0 \\ 0 & 0 & 0 & 0 & 0 & 0 & 0 & 0 & 0 & 0 & 0 & 0 \\ 0 & 0 & 0 & 0 & 0 & 0 & 0 & 0 & 0 & 0 & 0 & 0 \\ 0 & 0 & 0 & 0 & 0 & 0 & 0 & 0 & 0 & 0 & 0 & 0 \end{bmatrix} \quad (7-2-35)$$

Then, applying translation of Equation (2-2-17), the constitutive equation of the column is;

$$\begin{Bmatrix} P_1 \\ P_2 \\ \vdots \\ P_n \end{Bmatrix} = [K_C] \begin{Bmatrix} u_1 \\ u_2 \\ \vdots \\ u_n \end{Bmatrix} \quad (7-2-36)$$

where,

$$[K_C] = [T_C]^T [k_C] [T_C] + [T_{iC}]^T [K_G] [T_{iC}] \quad (7-2-37)$$

7.3 Unbalance force correction

a) Procedure to correct unbalance force

In nonlinear analysis, sudden change of spring stiffness sometimes causes severe error for estimating element force. For example, estimation of spring force f_{i+1} is overestimated in Figure 7-2-1 and “unbalance force” is defined as,

$$\Delta f = f_{i+1} - f'_{i+1} \quad (7-3-1)$$

where, f'_{i+1} is the force on the nonlinear skeleton curve

The most preferable way to minimize the error is to adopt iterative calculations such as Newton-Raphson method. However, this iteration may consume calculation time significantly. Therefore, the following simple way is adopted to correct unbalance force:

- 1) Calculate unbalance displacement Δd from the unbalance force Δf

$$\Delta d = \Delta f / k \quad (7-3-2)$$

where, k is the spring stiffness

- 2) Subtract unbalance displacement Δd from the increment displacement in the next step calculation

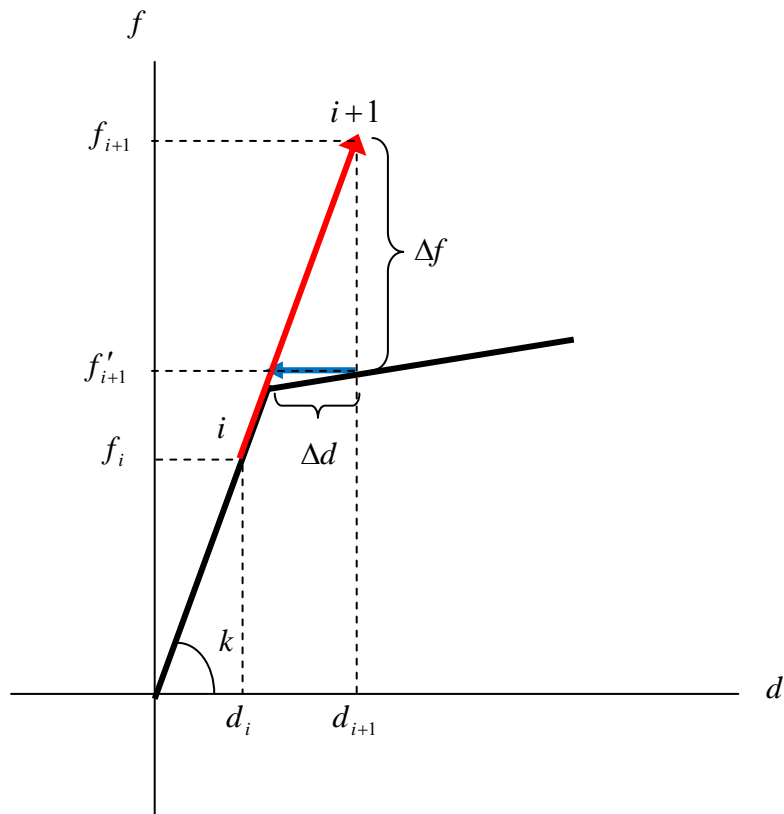

Figure 7-3-1 Unbalance force

b) Unbalance force correction of MS model

For the Multi-spring model (MS model) of Column element, the sum of the unbalance forces of nonlinear vertical springs in the member section is calculated as:

$$\Delta N = \sum_{i=1}^5 \Delta f_i = \sum_{i=1}^5 (\Delta f_{c,i} + \Delta f_{s,i}) \quad (7-3-3)$$

where $\Delta f_{c,i}$: unbalance force of concrete spring,

$\Delta f_{s,i}$: unbalance force of steel spring

The unbalance displacement is then calculated as:

$$\Delta D = \Delta N / \sum_{i=1}^5 k_i = \Delta N / \sum_{i=1}^5 (k_{c,i} + k_{s,i}) \quad (7-3-4)$$

where $k_{c,i}$: stiffness of concrete spring,

$k_{s,i}$: stiffness of steel spring

In the next step calculation, the increment displacement of each spring is adjusted as follows:

$$\Delta d'_i = \Delta d_i - \Delta D \quad (7-3-5)$$

where Δd_i : increment displacement of i-th spring

$\Delta d'_i$: adjusted increment displacement of i-th spring

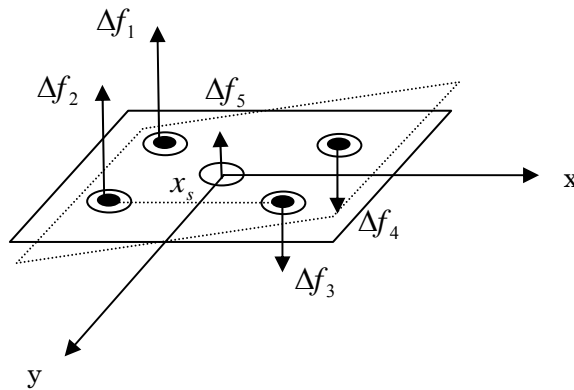

Figure 7-3-2 Unbalance force in MS-model

The same procedure is adopted for the MS model of Wall element.